

Antiquated Structural Systems

Illustrated

Introduction:

This document, which only includes illustrations and names of different antiquated structural systems without any corresponding structural or technical information, has been developed for the following reason. It has been my experience that when you encounter an archaic system that you are not familiar with, the biggest initial hurdle you face is identifying the type or specific name of the system. Once you know the name of the system it is much easier to look for and research any available information on the same system. If you know of any additional systems not included in this compilation of illustrations please contact me so this document can be updated on a regular basis. I can also be contacted for requests concerning load tables and other data relating to the following illustrated systems.

D. Matthew Stuart, P.E., S.E., F.ASCE, SECB
Structural Division Manager
Pennoni Associates Inc.
One Drexel Plaza
3001 Market Street, 2nd Floor
Philadelphia, PA 19104
Office 215-222-3000 x7895 | Direct 215-254-7895
Fax 215-222-0789 | Mobile 908-309-8657
mstuart@pennoni.com or dmstuart2@verizon.net

Brick Masonry:

- **Floor Arch** (Source: Kidder-Parker)

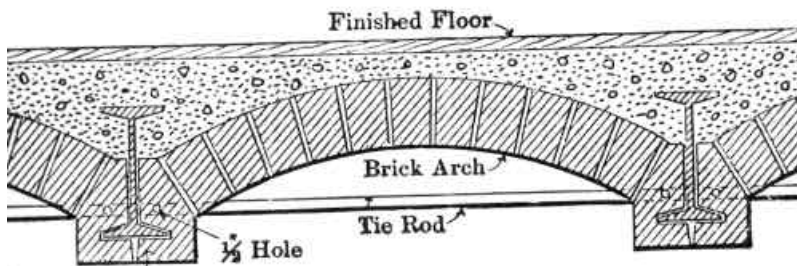

- **Footings** (Source: Building Construction and Superintendence)

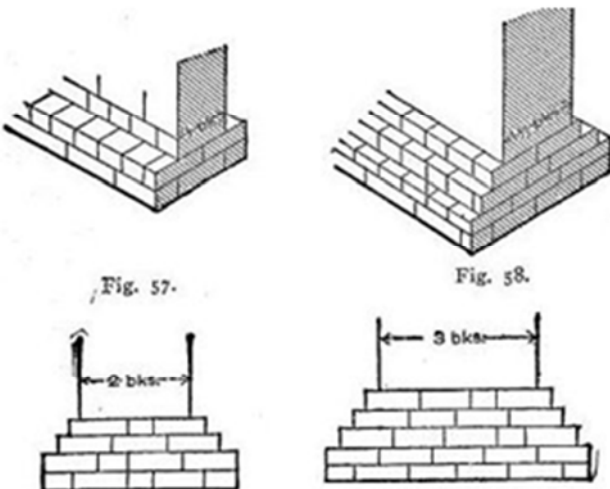

- **Walls**

- Façade (Source: Historic American Building Survey)



- Loadbearing (Source: DMS)



Cast Iron:

- **Columns** (Source: DMS)



- **Composite Cast Iron and Wrought Iron**
 - Perforated Girder (Source: Historic American Building Survey)



- Truss (Source: Peabody Essex Museum)

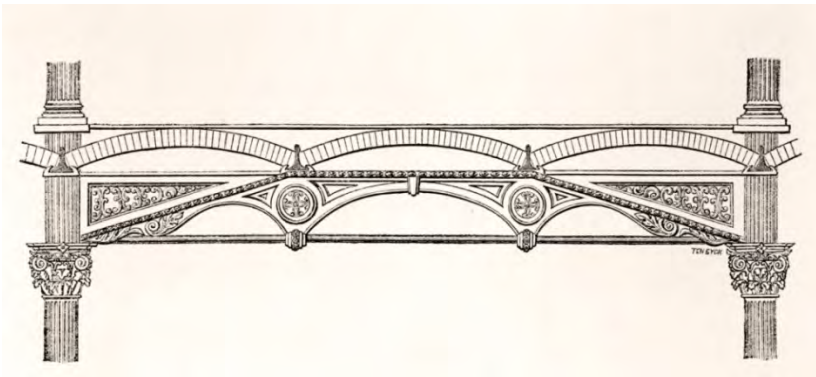

- **Façade** (Source: DMS)



- **Lintels** (Source: DMS)



- Y-Purlins and Inverted T Girders (Source: Freitag)

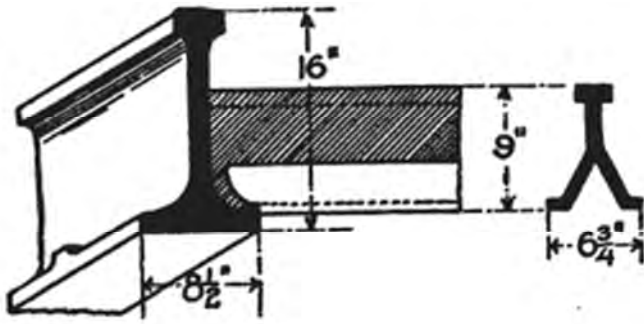

Cast Stone: (Source: DMS)



Clay-Tile:

- Ceiling Tile (Source: U.S. Patent Office)

(No Model.)
 P. B. WIGHT.
 FIRE PROOF CEILING.
 No. 322,873. Patented July 21, 1885.

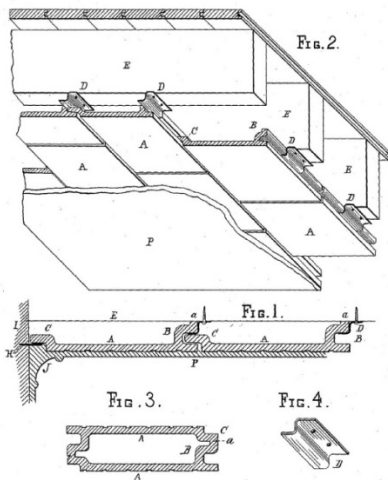

WITNESSES
A. H. Coffey
L. H. Hering

INVENTOR
P. B. Wight
 By *Edw. J. Hering*
Edw. J. Hering

- **Flat Arch**

- Combination Side and End Construction (Source: Kidder-Parker)

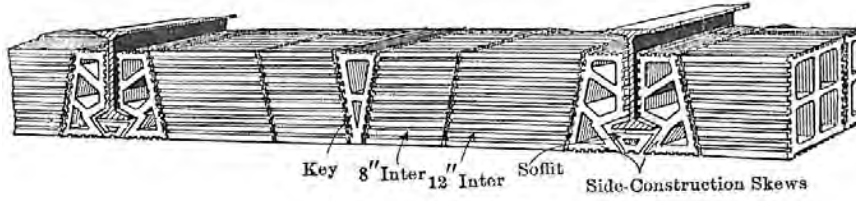

- End Construction (Source: Tile Engineering Handbook)

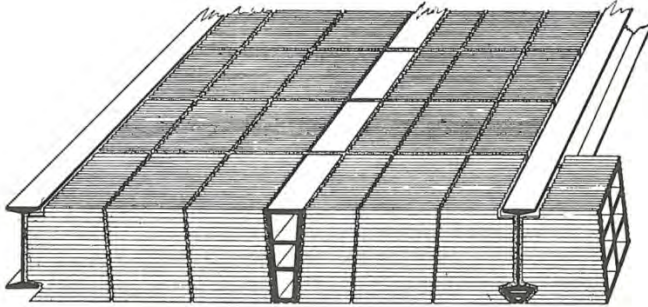

- Acme
(No Image Available)
- Fawcett
(No Image Available)

- Side Construction (Source: Freitag)

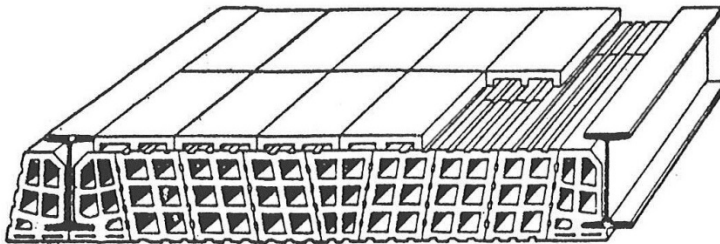

- **One-Way Joists**

- Faber (Source: Building Construction and Superintendence)

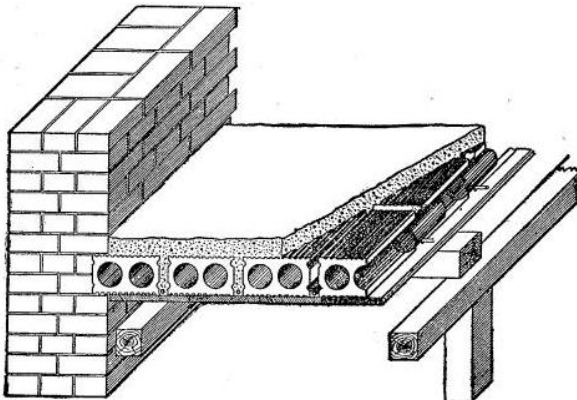

- Natcoflor (Source: Tile Engineering Handbook)

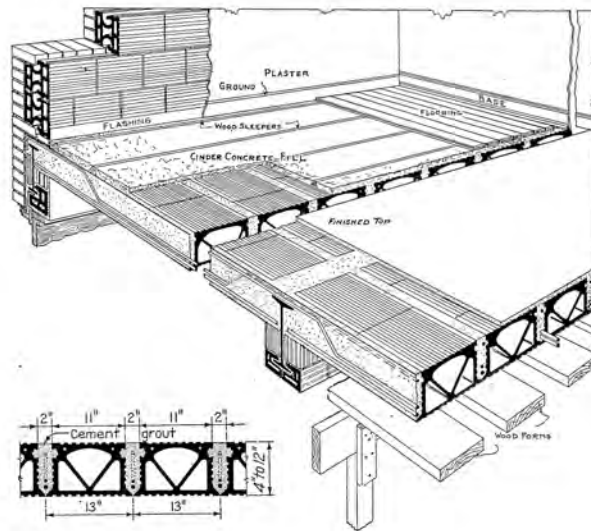

- Prefabricated

- Adel Joistile (Source: Tile Engineering Handbook)

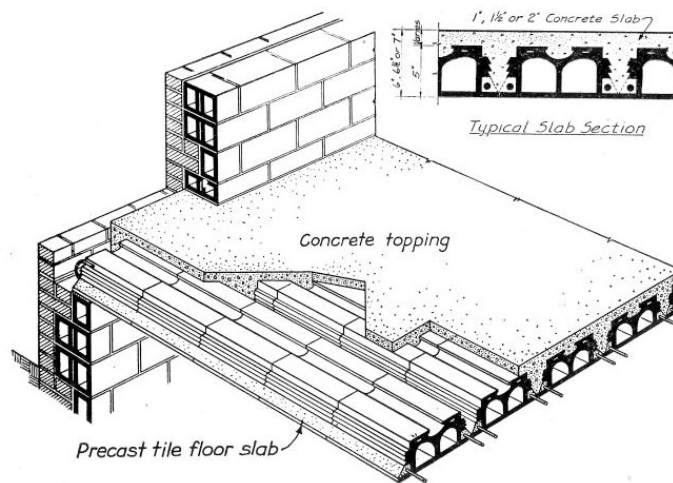

- Joistile (Source: Tile Engineering Handbook)

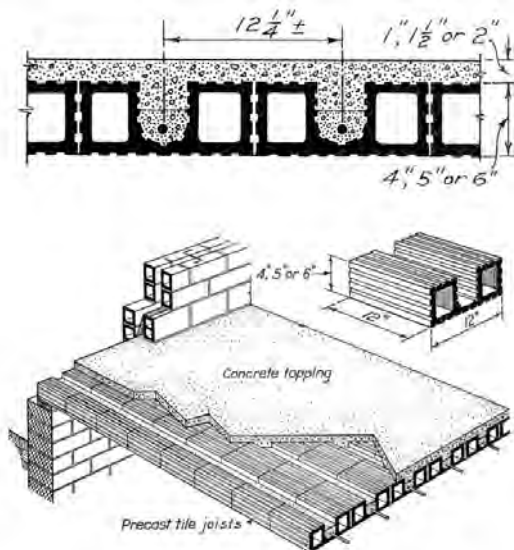

- Kalex (Source: Tile Engineering Handbook)

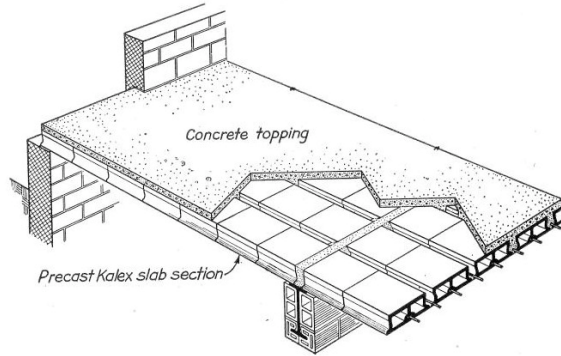
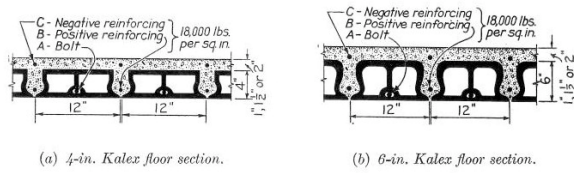

- Sheffield (Source: Tile Engineering Handbook)

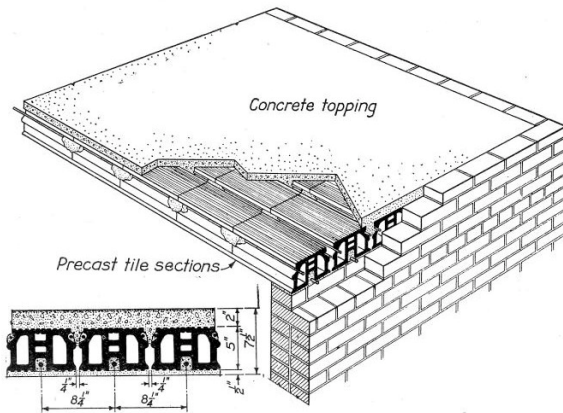

- T-Beam (Source: Tile Engineering Handbook)

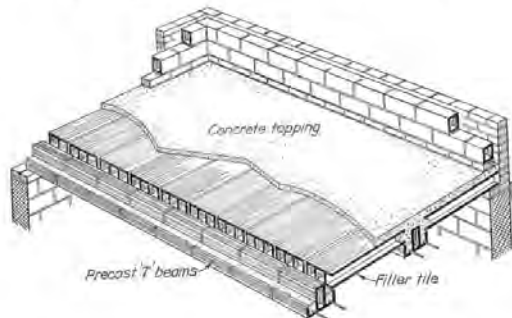
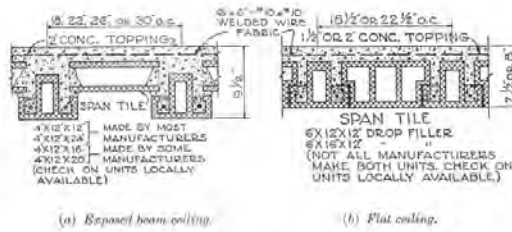

- Tilecrete
(No Image Available)
- U-Beam (Source: Tile Engineering Handbook)

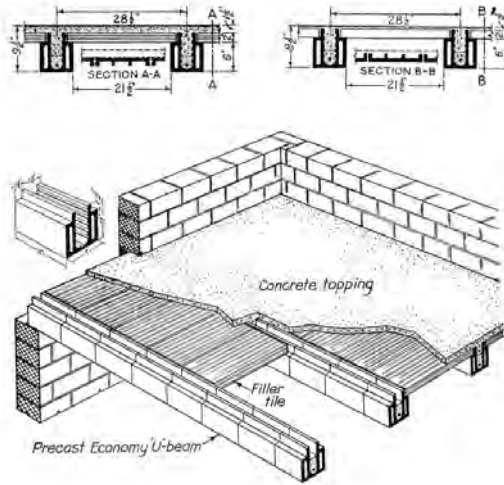

- United
(No Image Available)

- **Reinforced Flat Arch** (Source: Kidder-Parker)

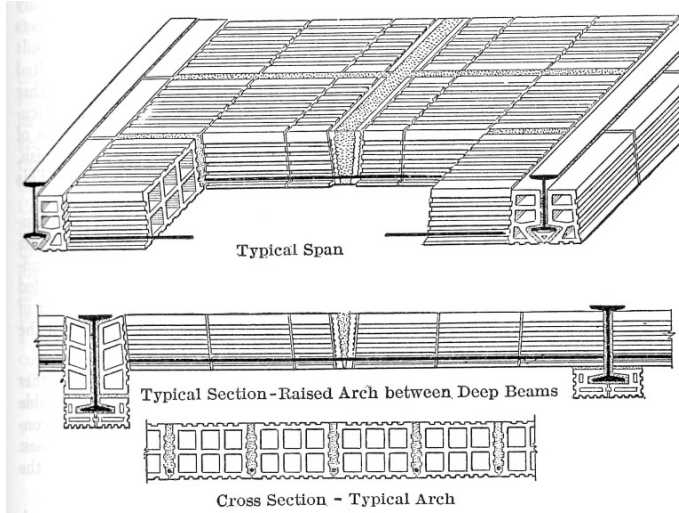

- **Excelsior** (Source: Freitag)

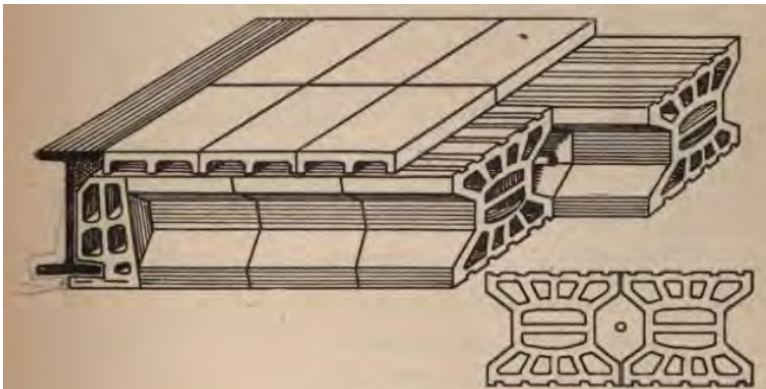

- Herculean (Source: Building Construction and Superintendence)

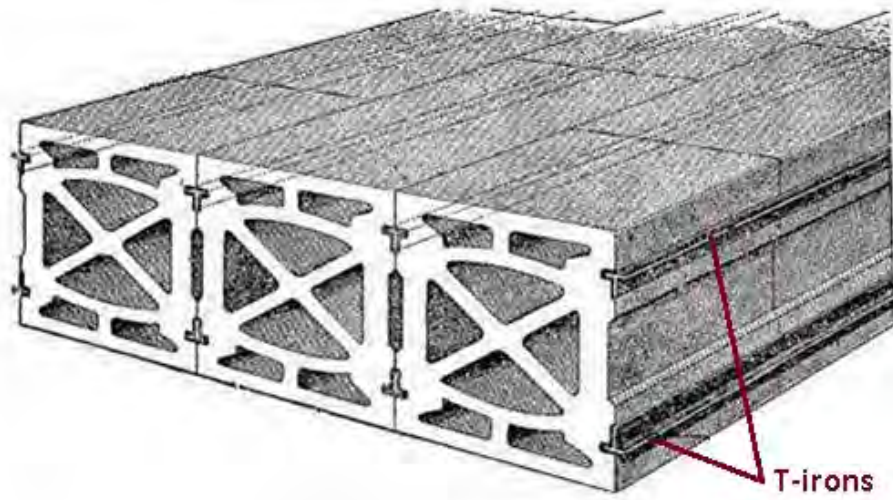

- Roof Book Tile (Source: Historic Preservation Education Foundation)

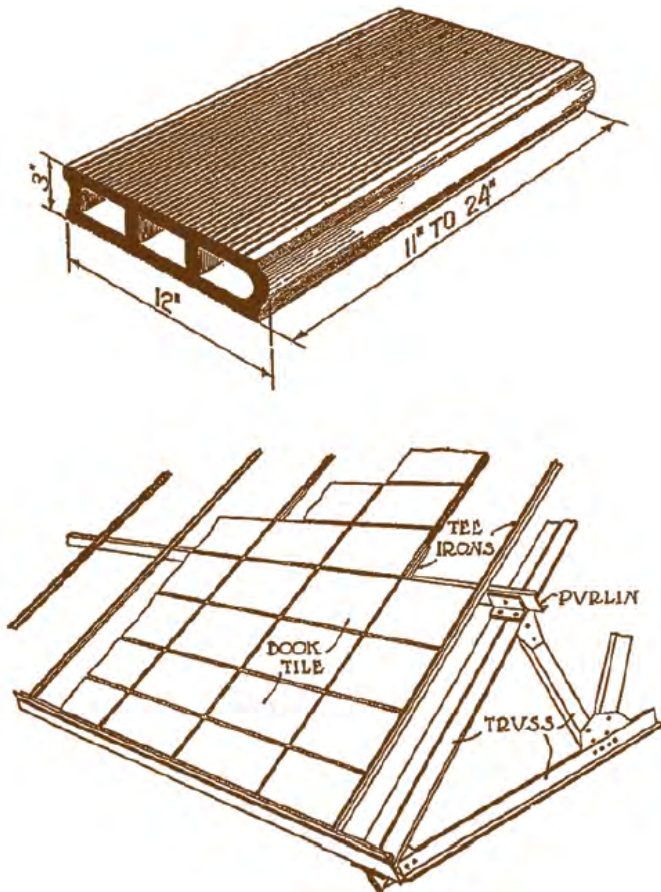

- Segmental Arch (Source: Tile Engineering Handbook)

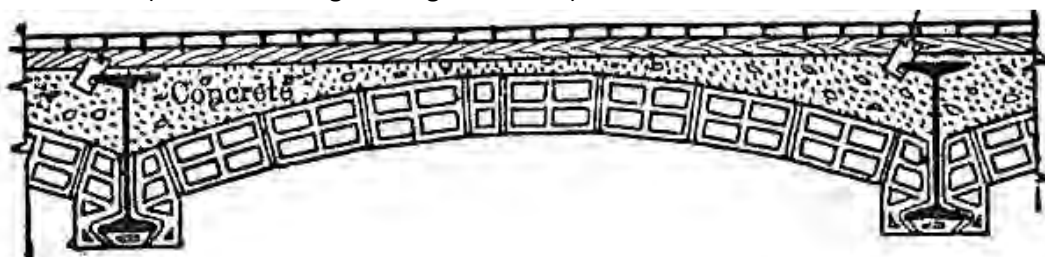

- **Two-Way Joists**

- Sandberg
(No Image Available)
- Schuster (Source: Tile Engineering Handbook)

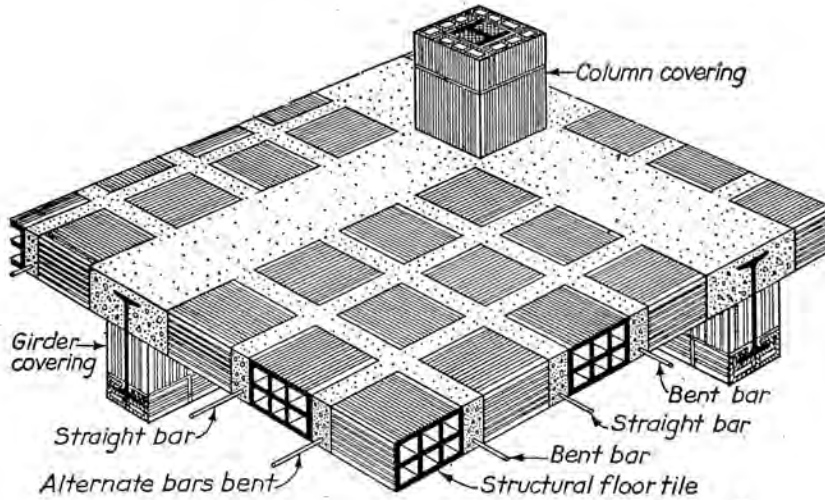

- Smooth-Ceiling
(No Image Available)

Concrete:

- **Arched**

- Rapp
 - Arched (Source: Building Construction and Superintendence)

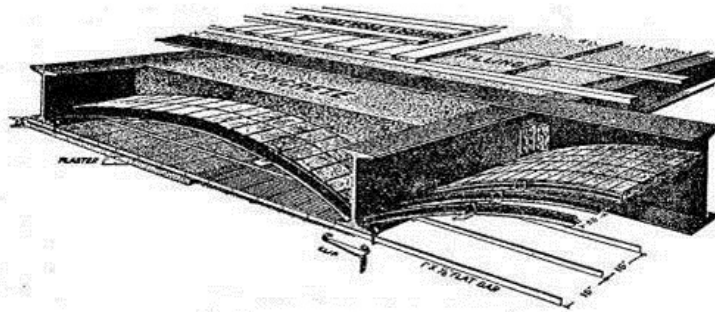

Type A

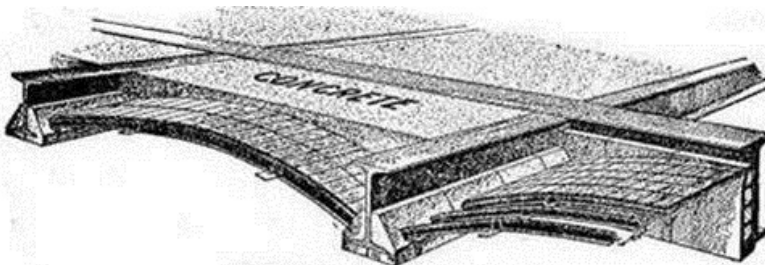

Type C

- Roebing

- Arched (Source: Building Construction and Superintendence)

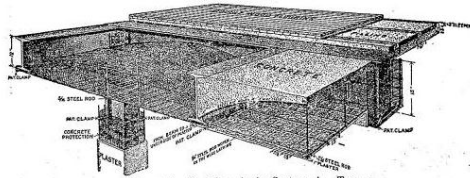

Fig. 348. Roebing Arch, System A. Type 1.



Fig. 349. Roebing Arch, System A. Type 2.

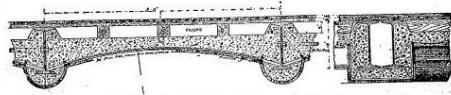

Fig. 350. Roebing Arch, System A. Type 2. Sleepers Depressed.

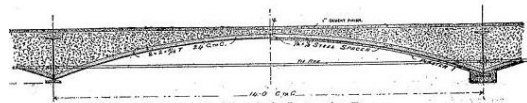

Fig. 351. Roebing Arch, System A. Type 4.

- Beckwith Hollow Tile (Source: Sara Wermiel)



- **Cement-Wood Fiber**

- Concrete Plank Company (Source: Concrete Plank Co.)

- Channel Slabs

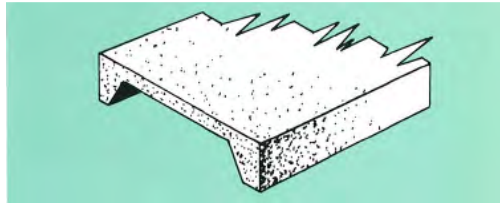

- Concrete Plank

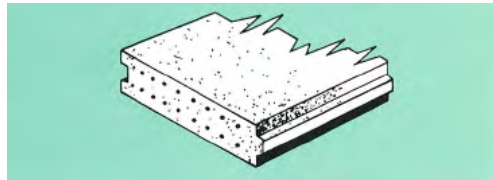

- Porex Plank

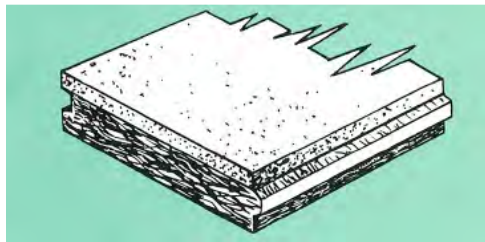

- Feather weight Flat Slab and Channel Slab (Source: Federal Cement Products)

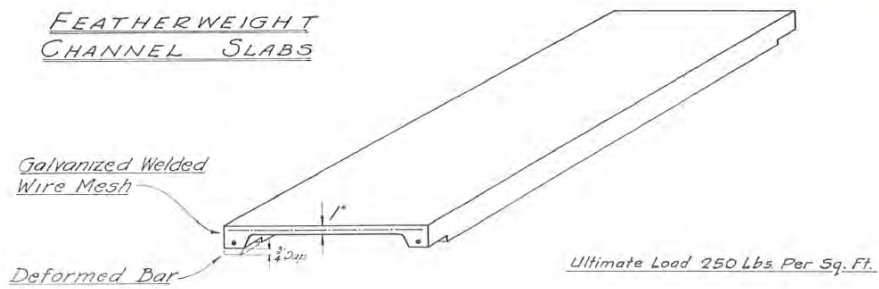

- Insulrock (Source: Flintkote Co.)



- PetriCal Deck (Source: Cornell Corporation)



- Draped Mesh (Source: DMS)



- Lock-Woven (Source: Building Construction and Superintendence)

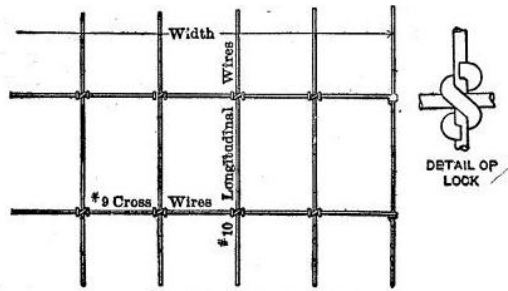
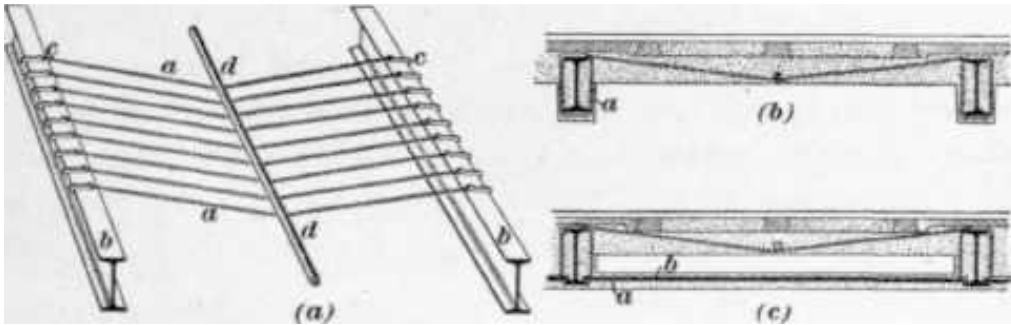

Fig. 378. Lock-woven Fabric.

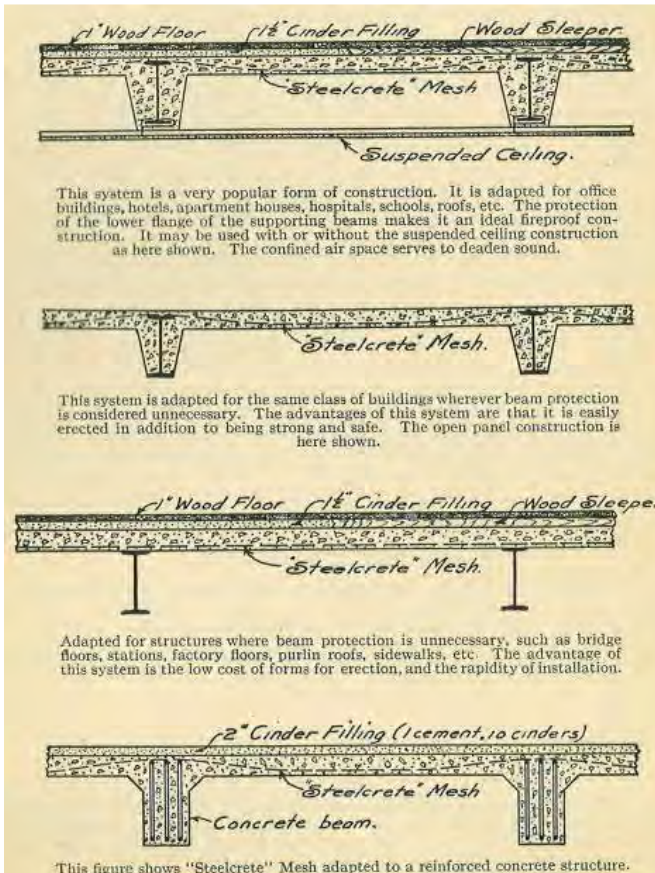

Fig. 379. Lock-woven Fabric Floor Construction.

- Metropolitan (Source: A Treatise on Architecture and Building Construction, Volume 2)



- Steelcrete (Source: Building Construction and Superintendence)



- Triangle (Source: Building Construction and Superintendence)

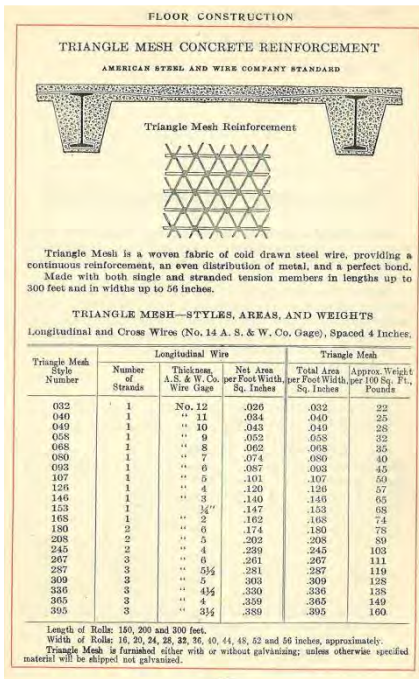

- White Concrete (Source: Building Construction and Superintendence)

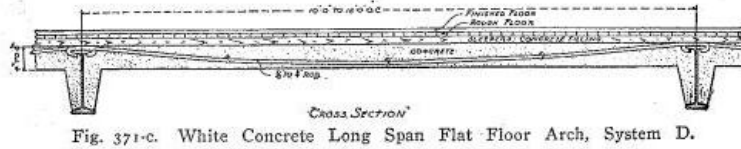

- Flat Plate/Slab Construction

- Four-Way (Source: CRSI)

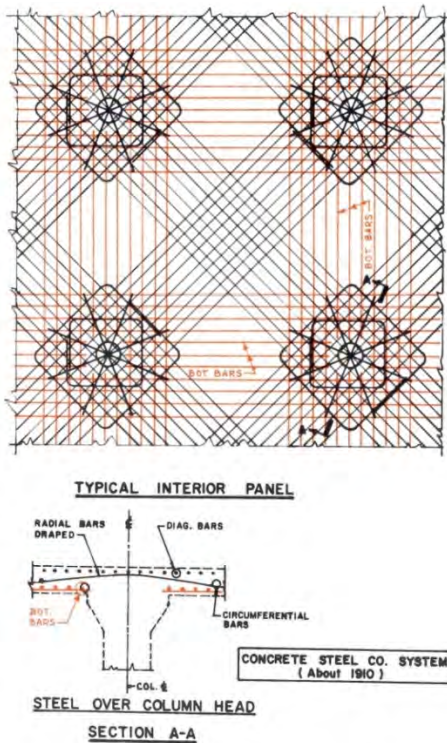
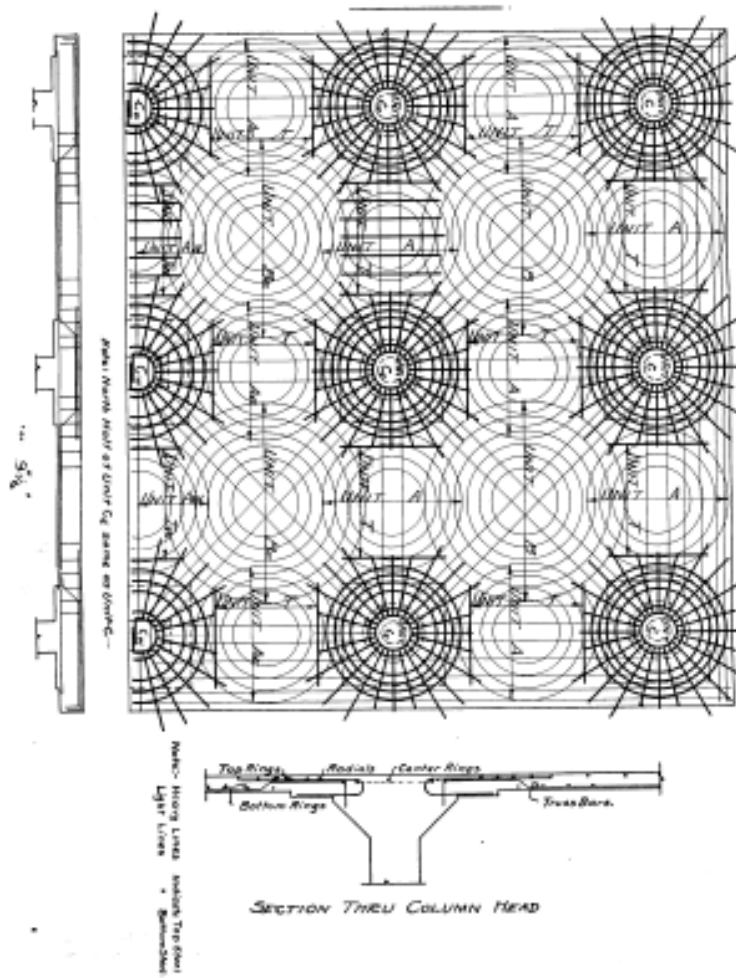
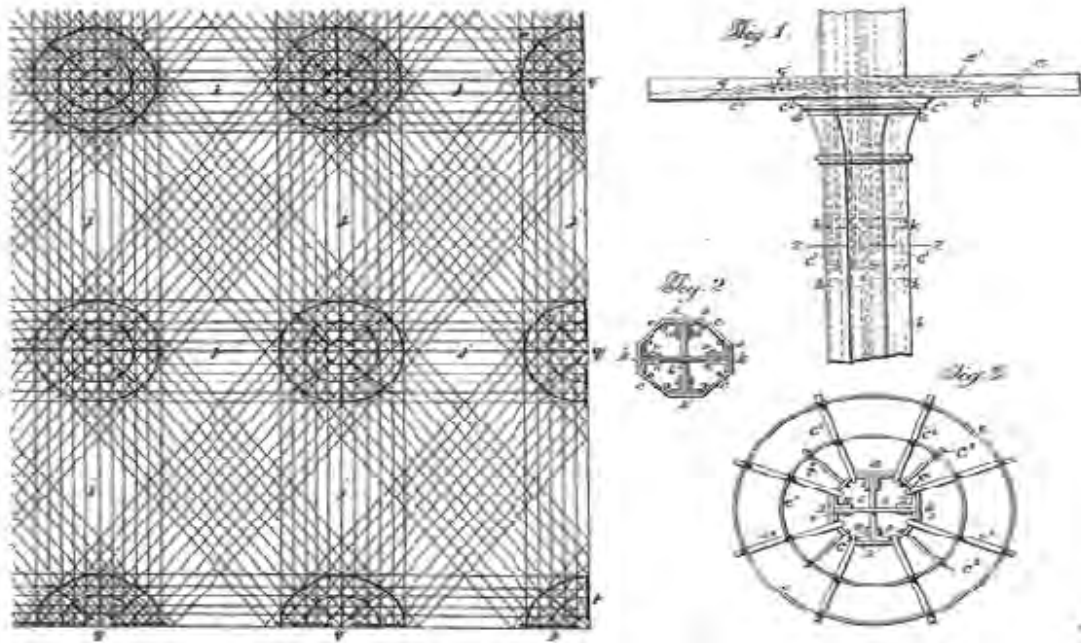

Fig. 4. Concrete Steel ("Cantilever") System (4-Way)

- S.M.I. System (Source: ACI)



- Turner Mushroom System (Source: Meghan Elliott)



- Two-Way
(No Image Available)

- **Gypsum Concrete**

- Keydeck Truss Tees (Source: U.S. Gypsum Co.)

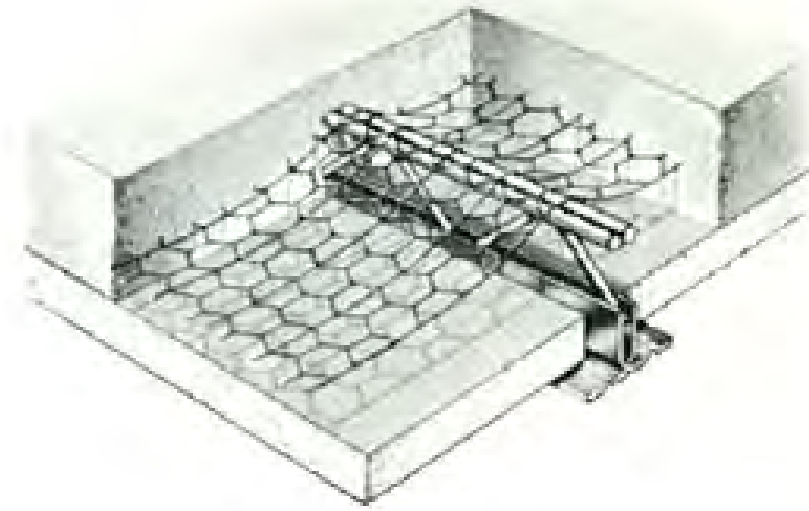

- United States Gypsum

- Floor Plank; with metal edge (Source: U.S. Gypsum Co.)



- Gypsum Roof Tile (Source: U.S. Gypsum Co.)

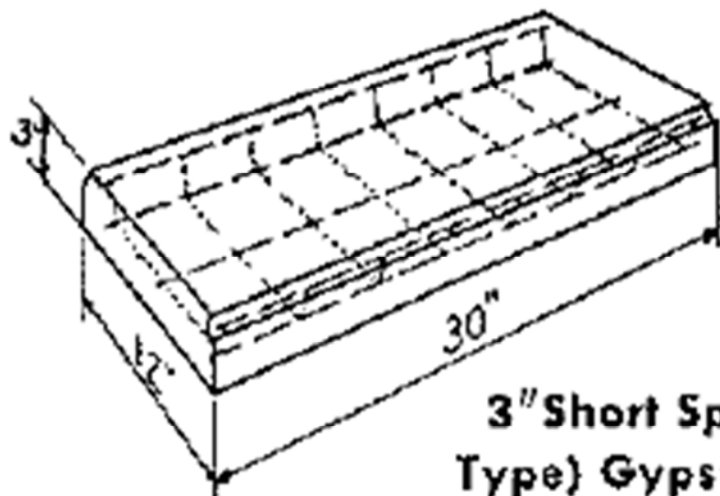

3" Short Span (Nailing Type) Gypsum Roof Tile

- Metal Edge Plank (Source: U.S. Gypsum Co.)

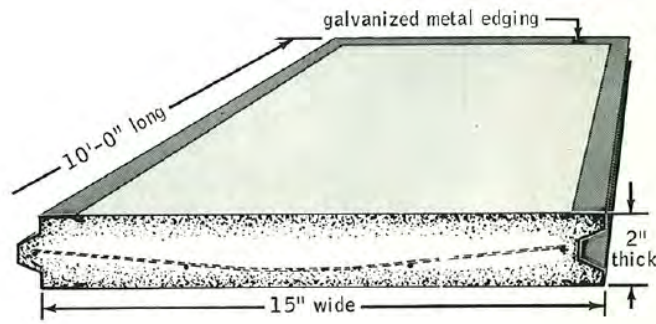

- Poured Gypsum Roof Deck; on formboard (Source: U.S. Gypsum Co.)

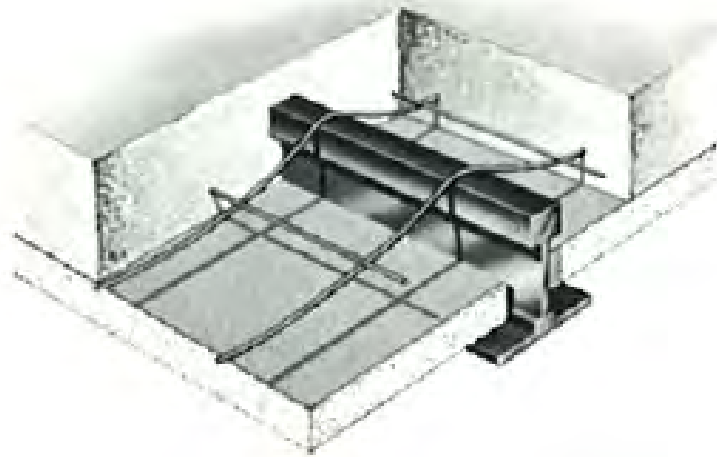

- Metal Tile (Source: Building Construction and Superintendence)

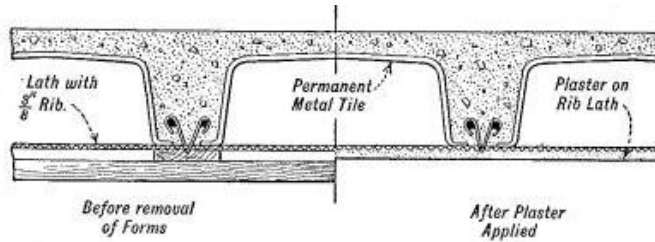

- Adjustable (Source: Building Construction and Superintendence)

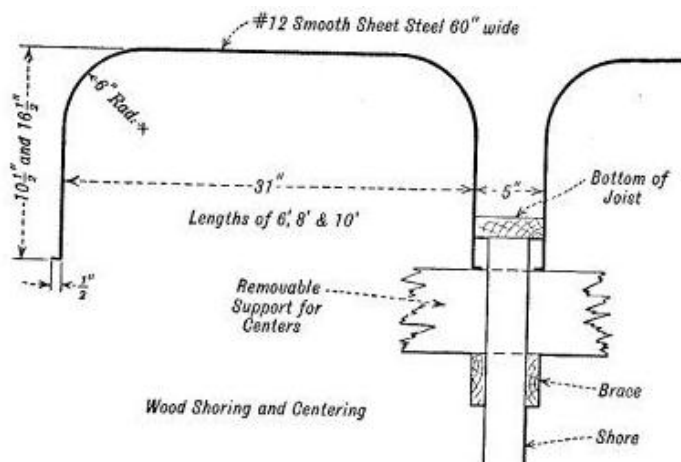

- GF (Concrete Engineers Handbook)

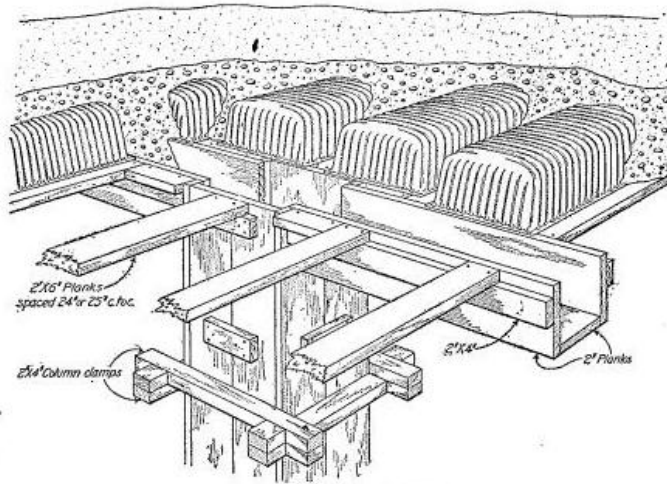

- Truscon Ribbed Florestyle; permanent, and Floreform; removable (Source: Truscon Buildings Co.)

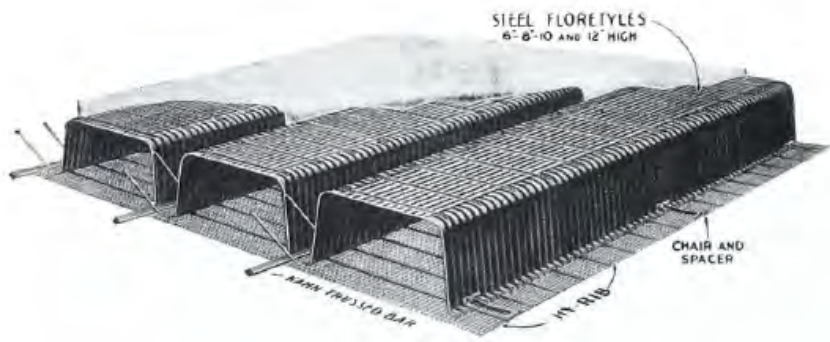

- **One-Way Slab**

- Columbian (Source: Building Construction and Superintendence)

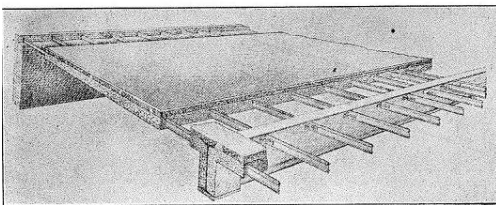

Fig. 360. Columbian System. Long Span. System B.

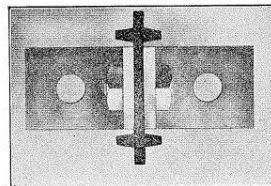

Fig. 361. Columbian System. Angle-bolt Connection.

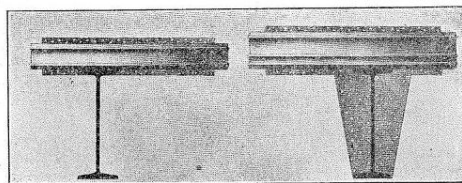
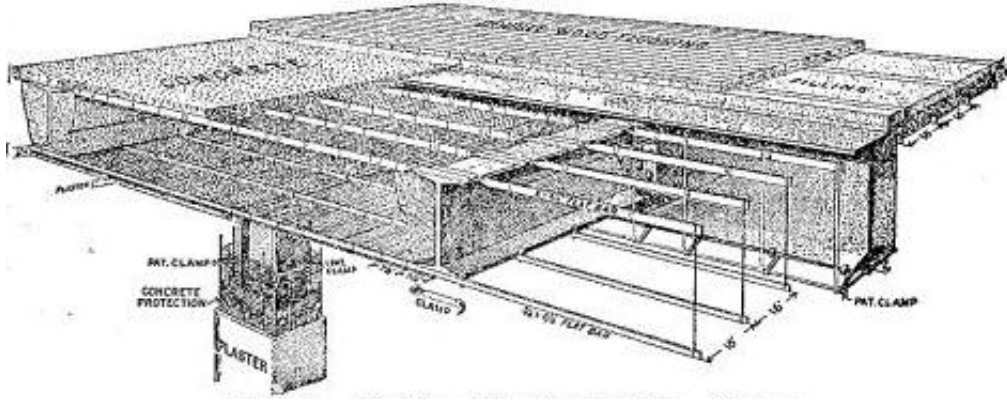

Fig. 362. Columbian System. Long Span. System C.

- Roebling Flat (Source: Building Construction and Superintendence)



- Thompson Floor
(No Image Available)

- **Post-Tensioned**

- Breeko Block Beam (Source: Ross Bryan Associates)

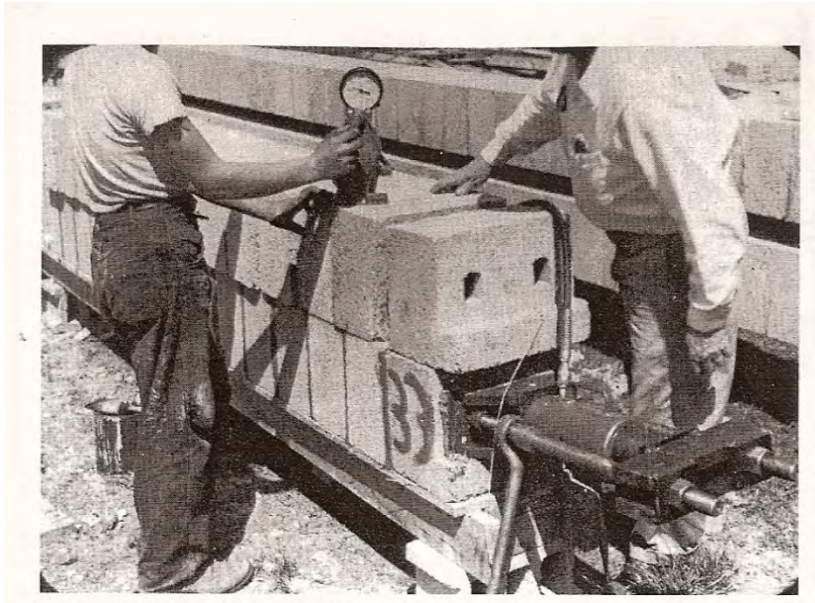

- **Precast**

- Box Beam (Source: Modern Prestressed Concrete)

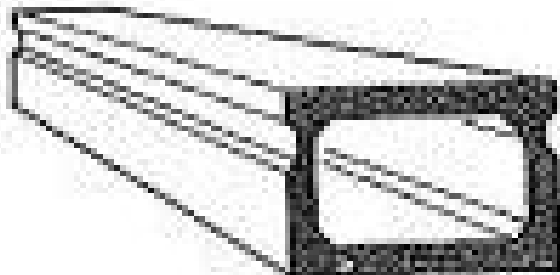

- Cantilite
 - Concrete Joist (Source: Concrete Plank Co.)

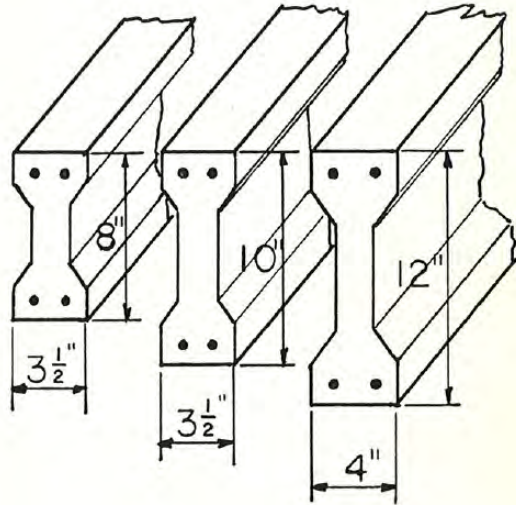

- Lap-Plank (Source: Concrete Plank Co.)

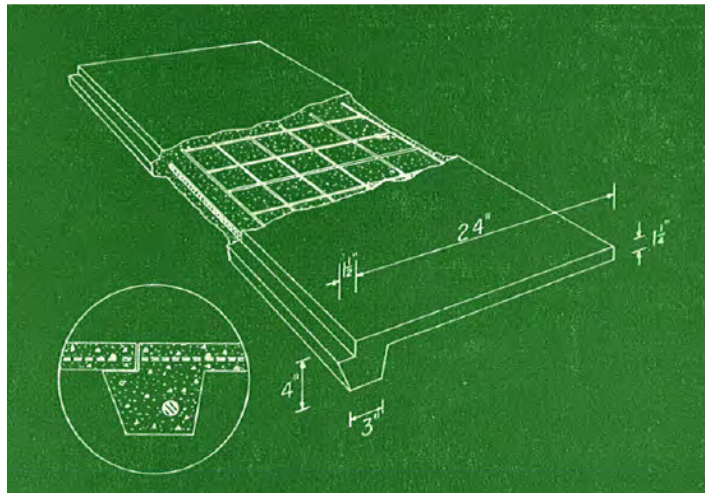

- Channel Slab (Source: Mid Con Products)

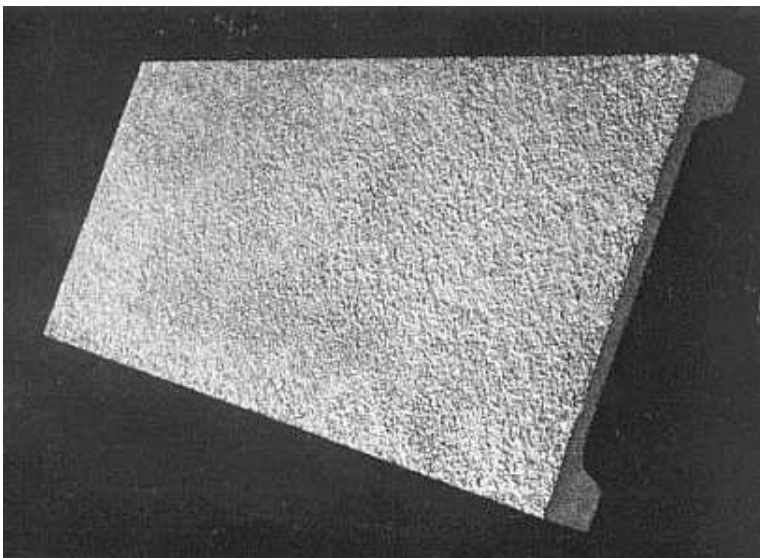

- Double Tee (Source: OSCO Construction Company)



- Channel Tee (Source: Modern Prestressed Concrete)

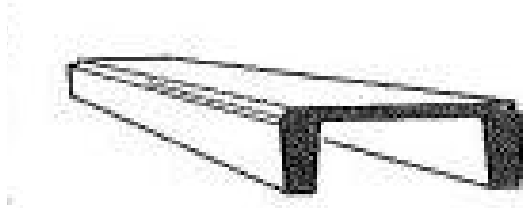

- Monowing (Source: Modern Prestressed Concrete)



- Earley Process (polychrome, architectural mosaic concrete)
(No Image Available)

- F&A (Source: Nitterhouse Precast Concrete)

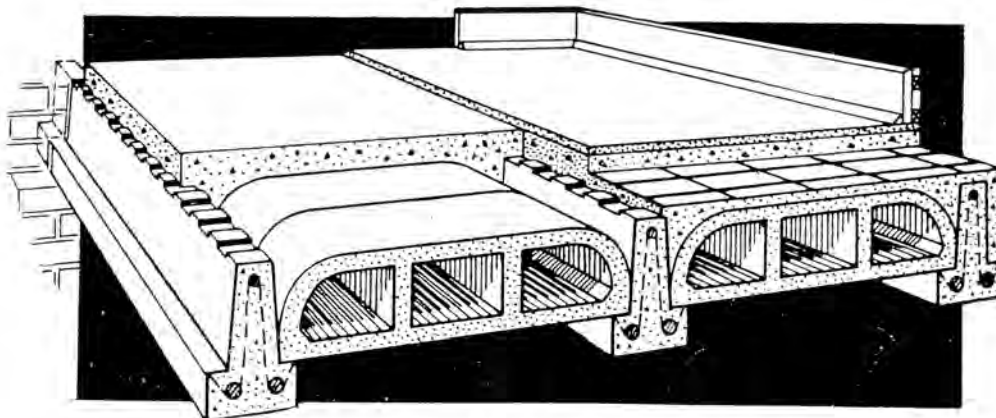

- Gypsteel (Source: Kidder-Parker)

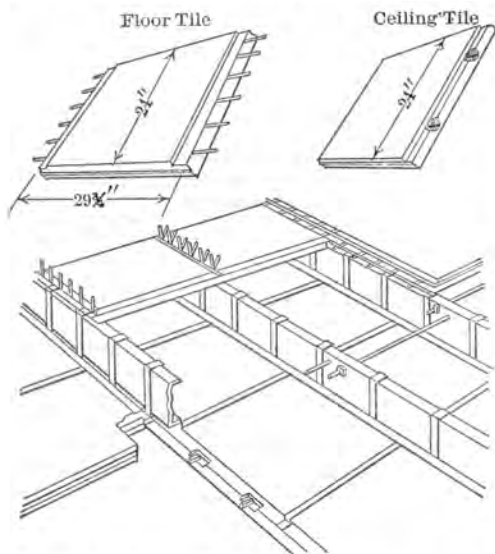

- Hollowcore Plank (Source: Modern Prestressed Concrete)

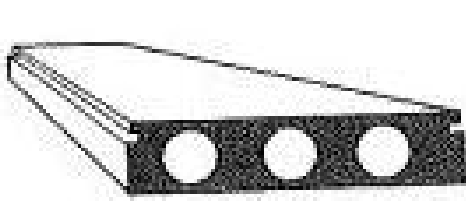

- I-Beam (Source: Modern Prestressed Concrete)

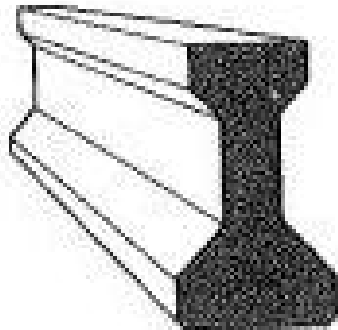

- Inverted Tee Beam (Source: Modern Prestressed Concrete)

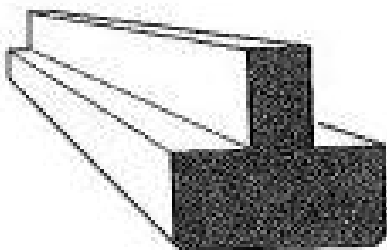

- Keystone Joist (Source: Nitterhouse Precast Concrete)

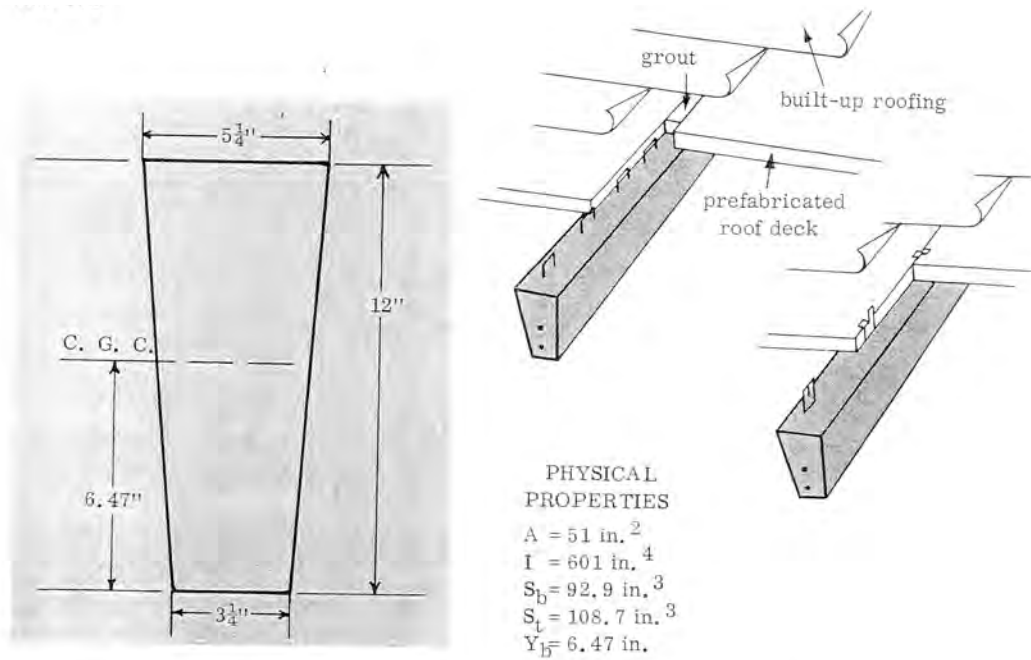

- Kurtz I-Joists (Source: Kurtz Precast Corporation)



- Lith-I-Bar (Source: Kidder-Parker)

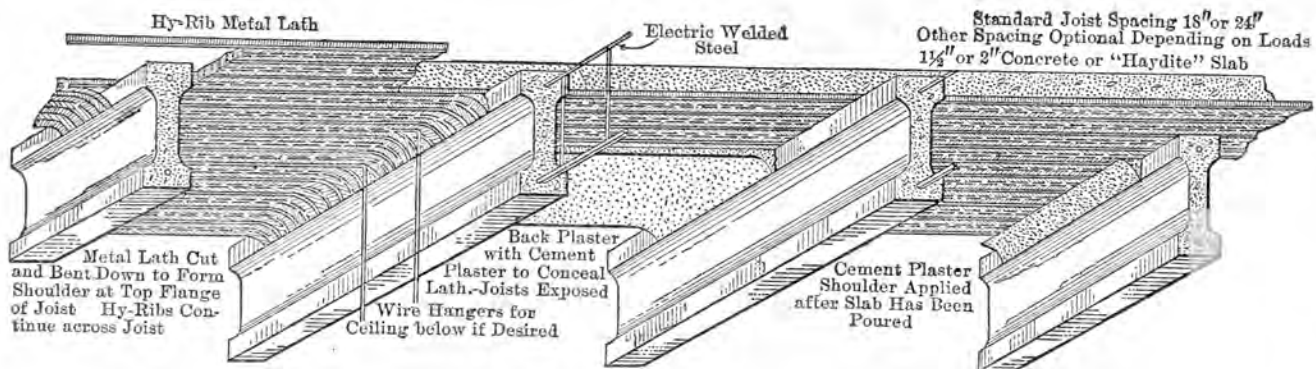

- Miller (Source: Kidder-Parker)

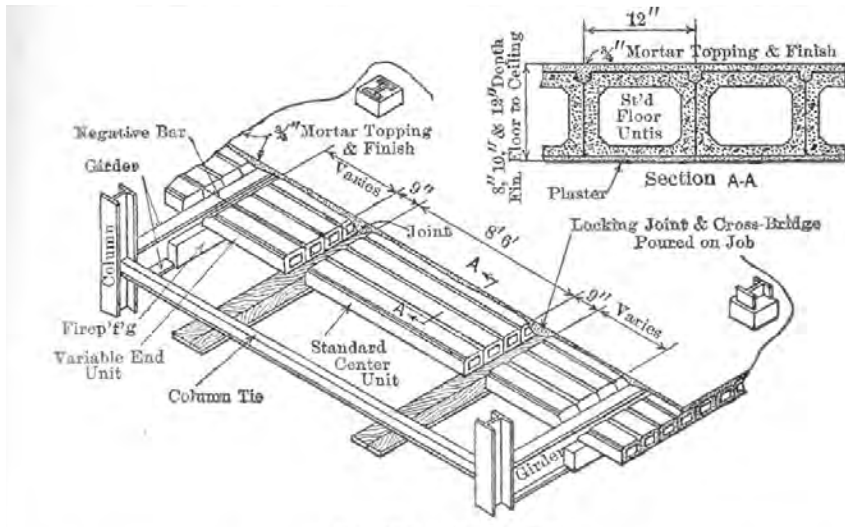

- Porete (Source: Kidder-Parker)

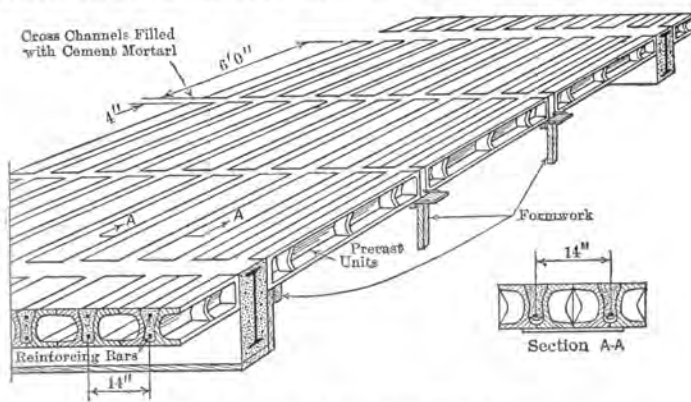

- Pyrobar (Source: Kidder-Parker)

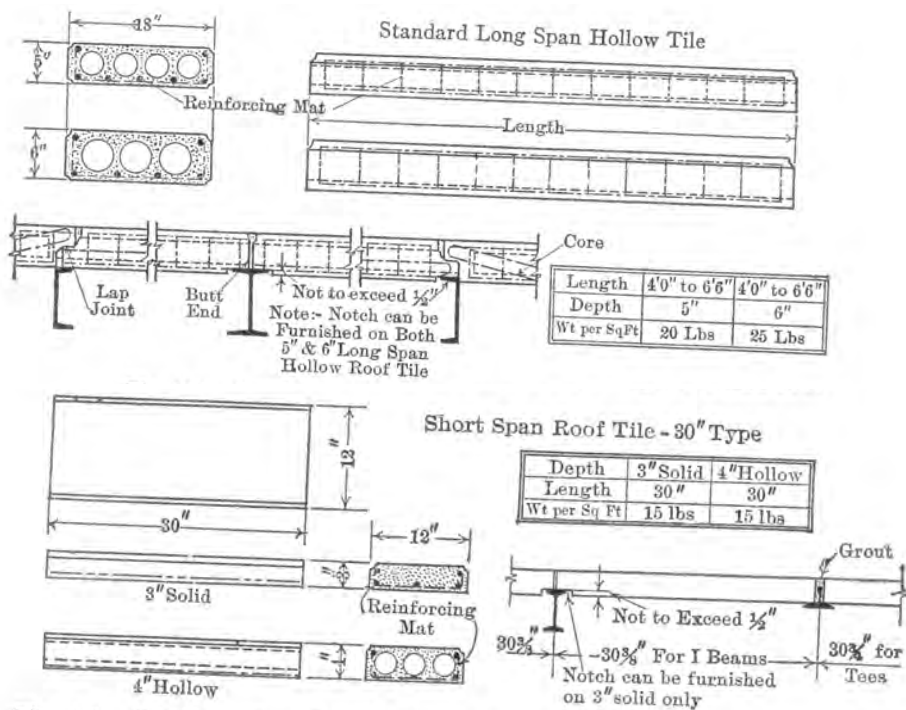

- Quad Tee (Source: Oldcastle Precast)

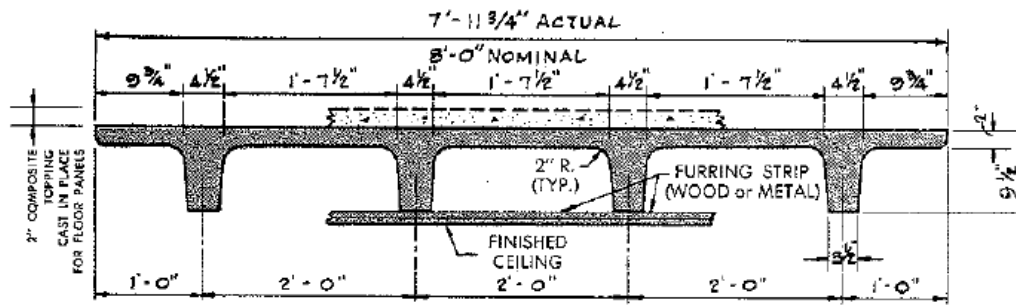

- Rackle Precast

- Channels (Source: George Rackle & Sons, Co.)

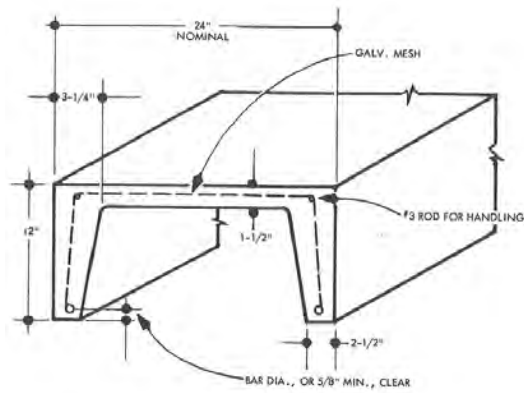

- Rutten (Source: U.S. Patent Office)

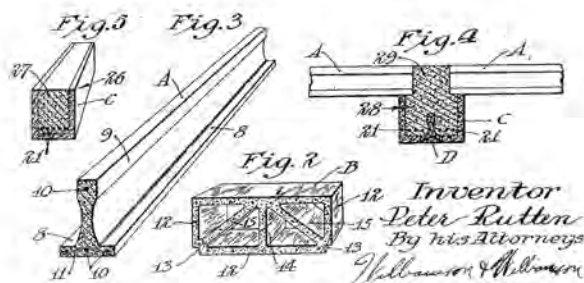
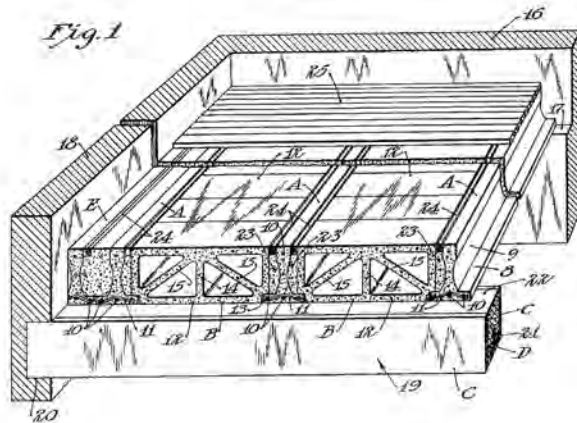

- Single Tee (Source: Modern Prestressed Concrete)

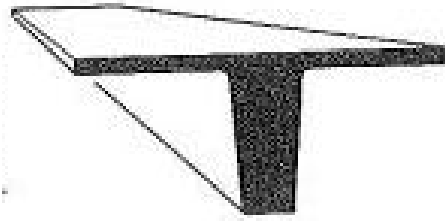

- Tee Joist (Source: Nitterhouse Precast Concrete)

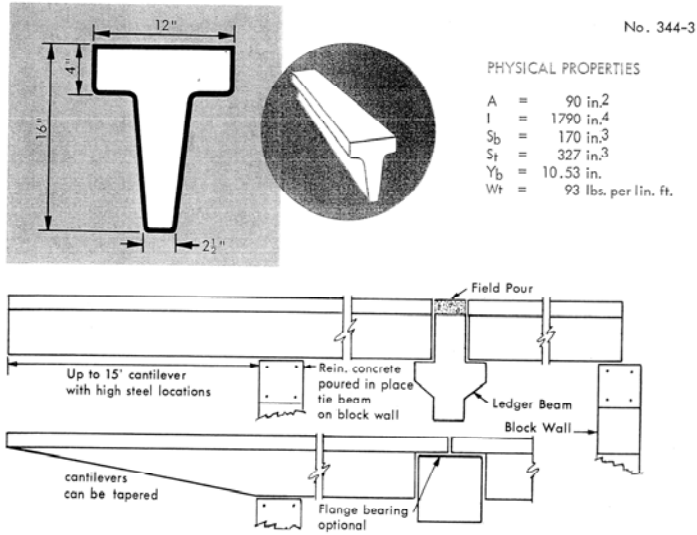

- Tee Stone (Source: Kidder-Parker)

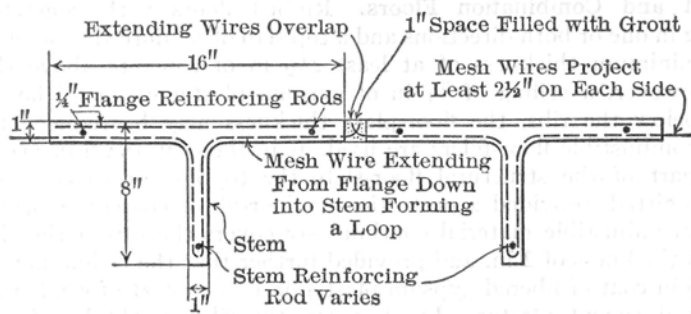

- Twin-Bar
 - I-Joist (Source: Structural Precast Company)

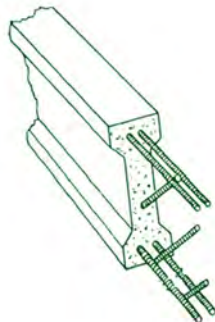

- Longspan Channel Slab (Source: Structural Precast Company)

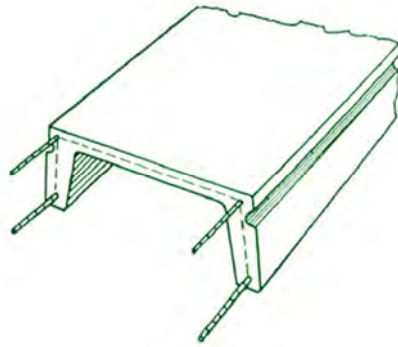

- Waite's I-Beam (Source: Kidder-Parker)

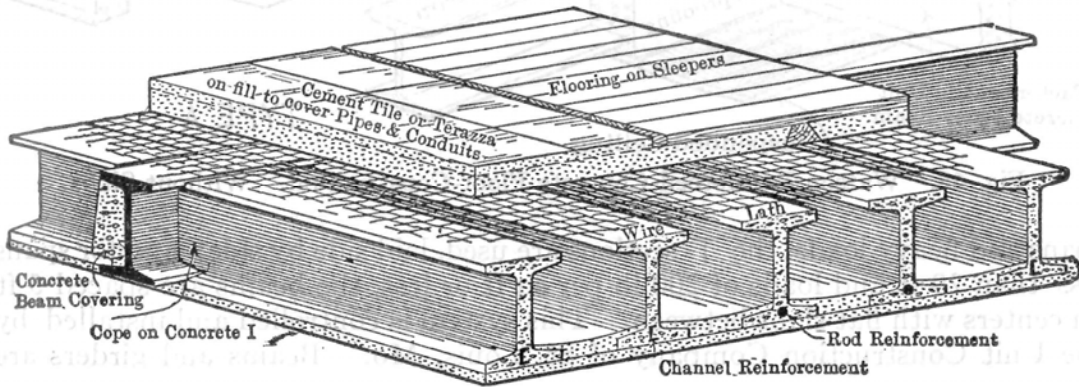

- Watson Reinforced Concrete Floor (Source: Kidder-Parker)

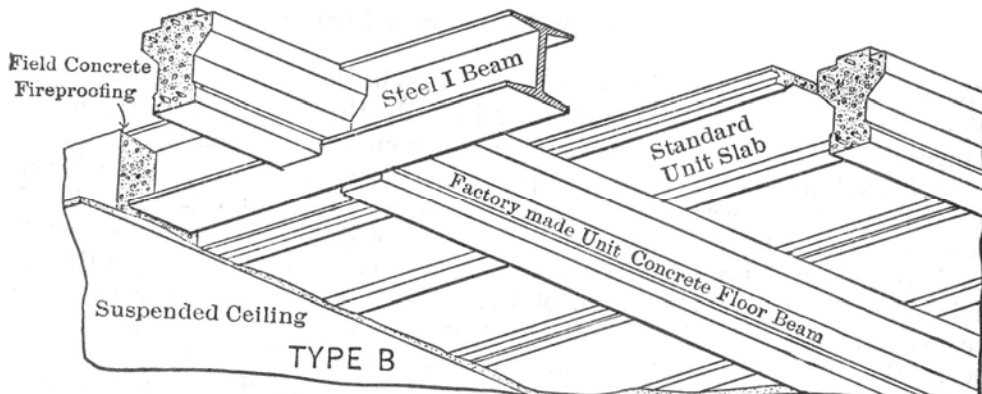
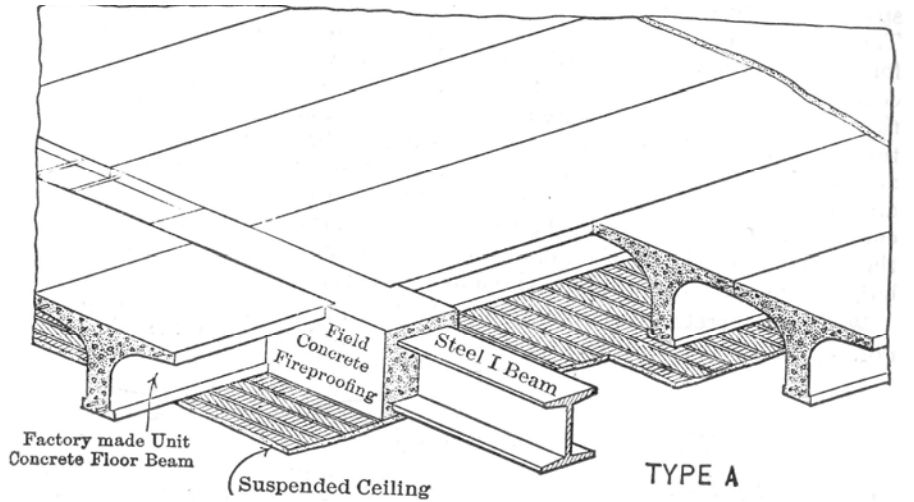

Metal Deck:

- **Granco** (Source: Granco)

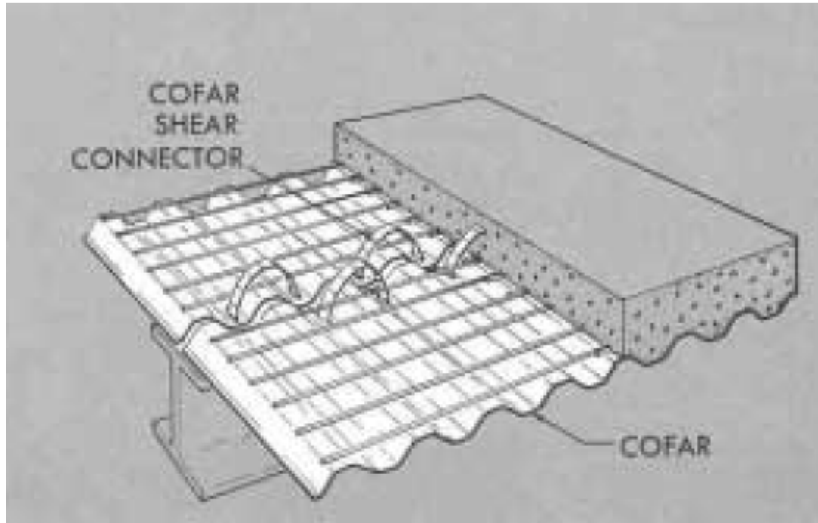

- **HH Roberson FK** (Source: HH Robertson)

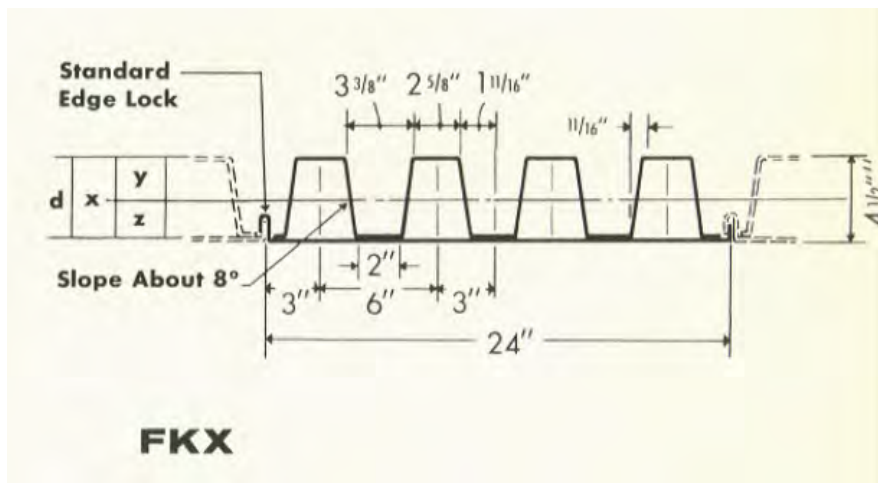

- **Truscon Hy-Rib** (Source: Truscon Buildings Co.)



Reinforcing:

- **Deformed**
 - American
(No Image Available)

- Concrete Steel Company (Source: Trussed Concrete Steel Co.)

- Round



- Square



- Cup
(No Image Available)

- Diamond
(No Image Available)

- Elcannes (Source: Pocket Companion)

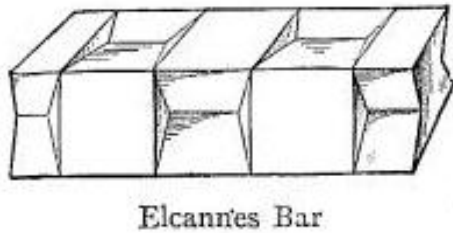

- Havemeyer (Source: Pocket Companion)

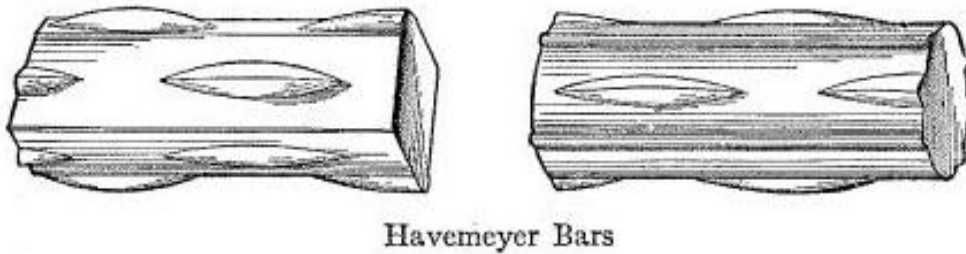

- Herringbone (Source: Pocket Companion)



- Johnson (Source: Building Construction and Superintendence)
 - Corrugated Flats

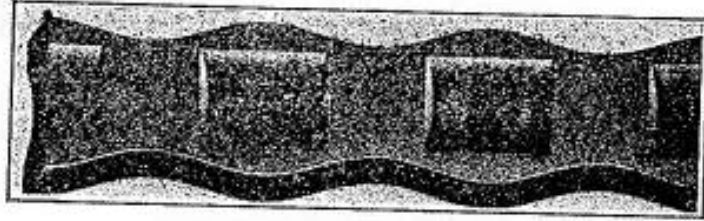

- Corrugated Rounds

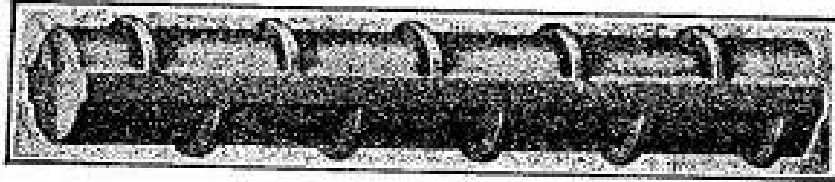

- Corrugated Squares (New and Old Style)

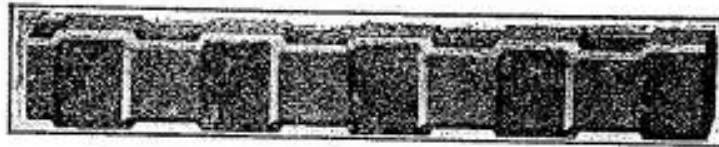

Fig. 509. Johnson Bar. Corrugated Squares. New Style.

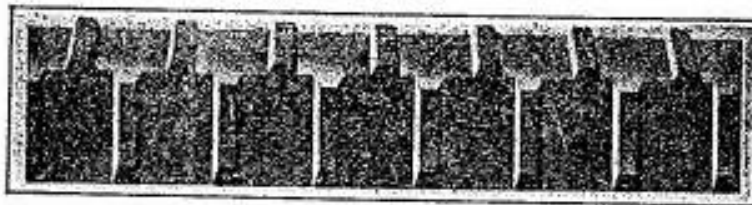
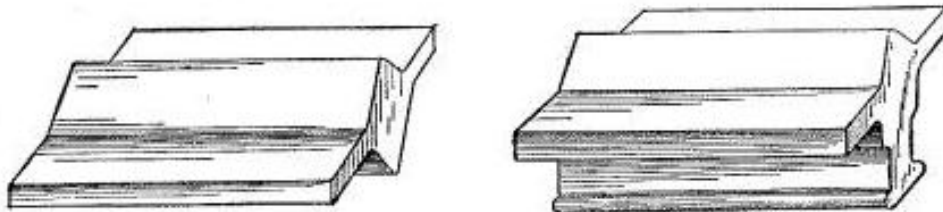

Fig. 510. Johnson Bar. Corrugated Squares. Old Style.

- Kahn Wing Bars (Source: Handbook of Building Construction)



Kahn Wing Bars

- Lug
(No Image Available)

- Monotype (Source: Handbook of Building Construction)

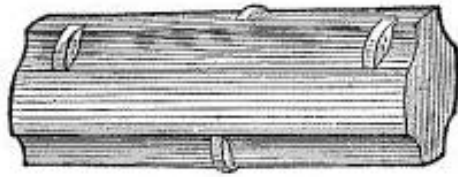

Monotype Bar

- Priddle Inner Bond Bar (Source: Building Construction and Superintendence)



Fig. 512. Priddle Inner Bond Bar.

- Rib Bar
(No Image Available)
- Scofield Bar
(No Image Available)
- Slant
(No Image Available)
- Thatcher
(No Image Available)
- Truscon (Source: Truscon Steel Company)

- Round Rib

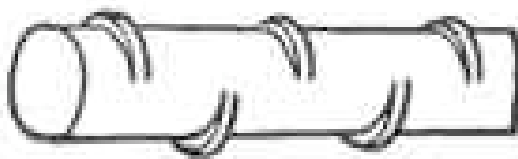

Round Rib Bar

- Square Rib



Square Rib Bar

- **Plain**
(No Image Available)

- **Trussed** (Source: Concrete Engineers Handbook)

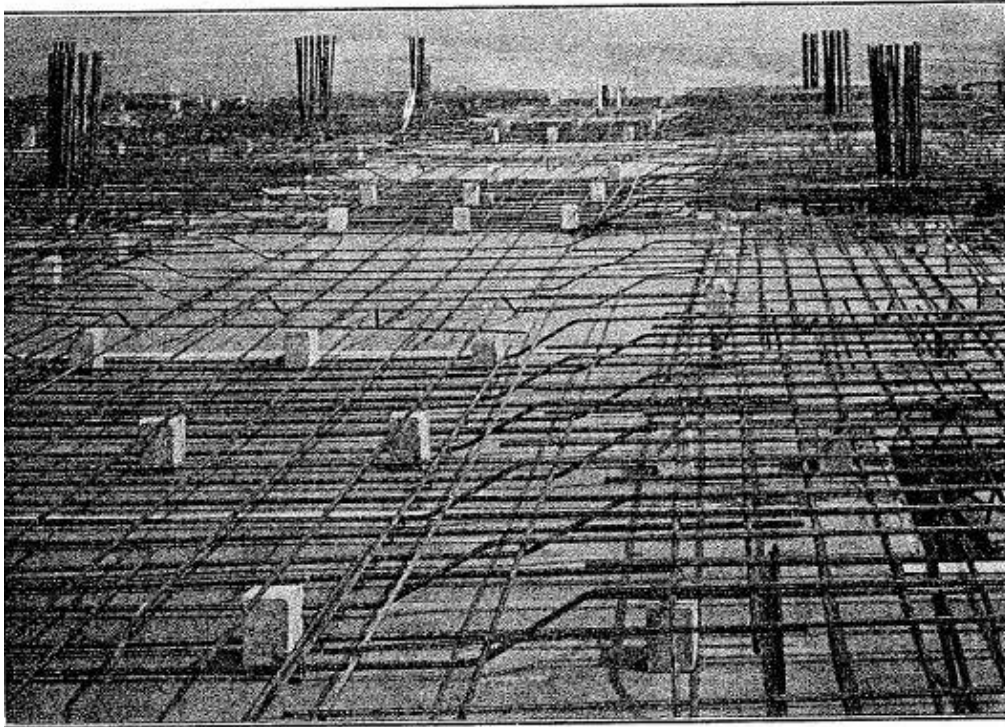

- Prefabricated
 - Corr
(No Image Available)
 - Cummings (Source: Radford's Cyclopedia of Construction)

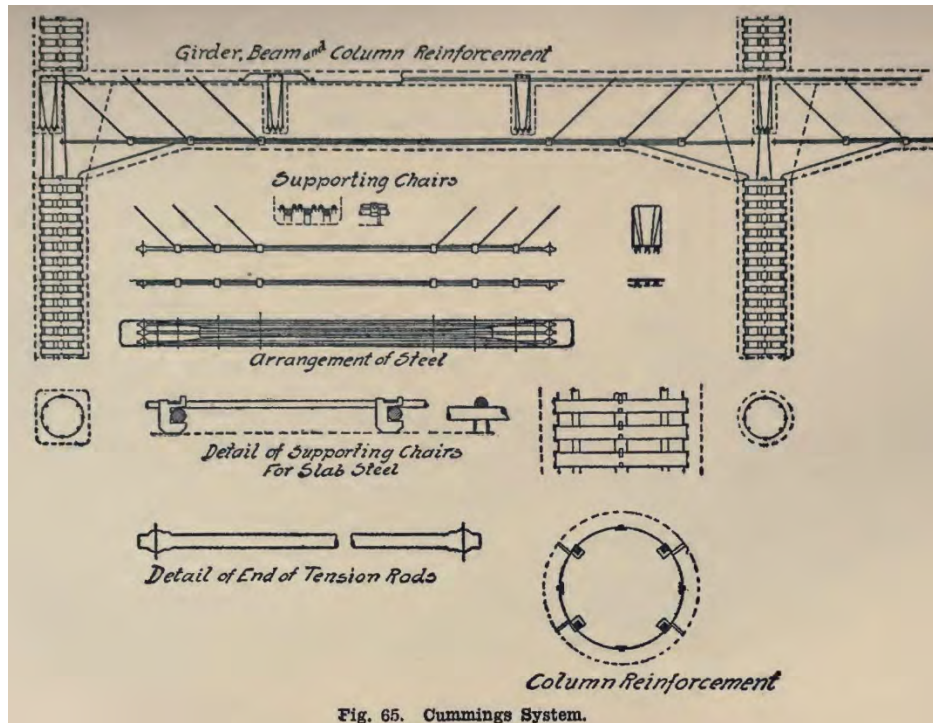

- Gabriel (Source: Radford's Cyclopedia of Construction)

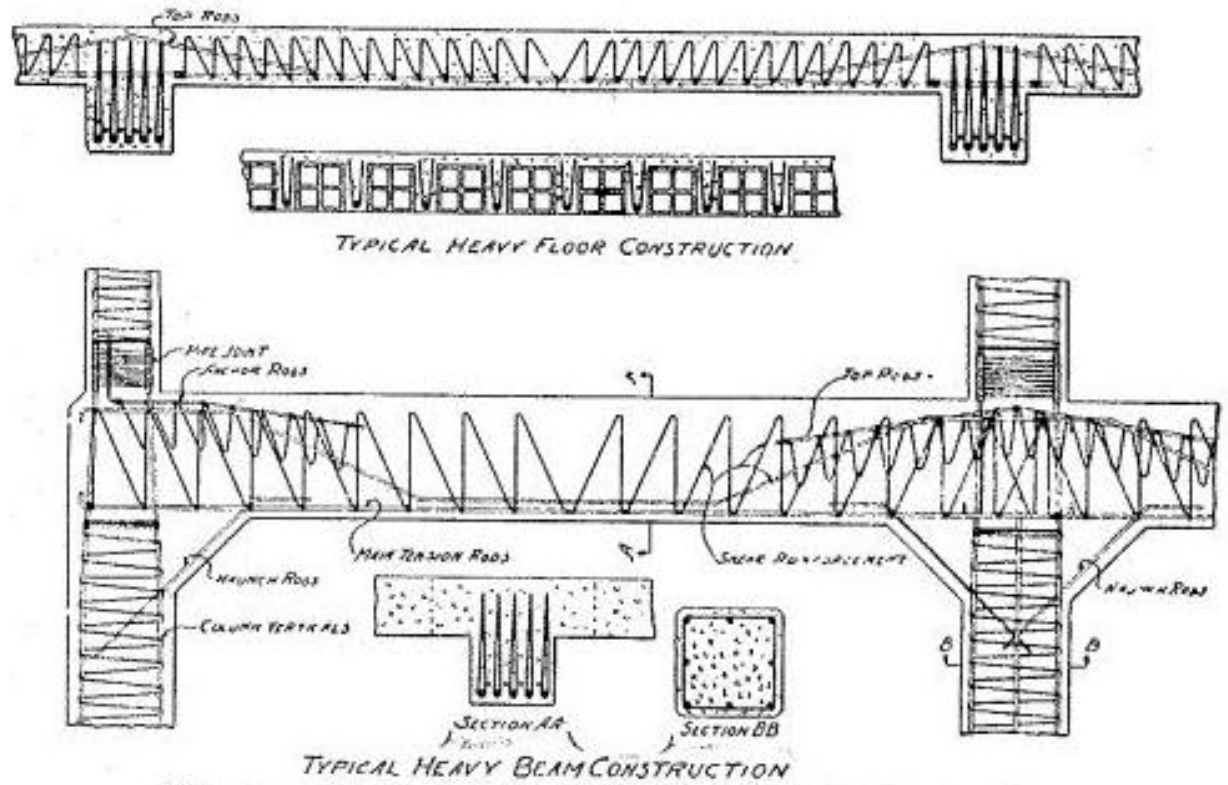

- Hennebique (Source: Building Construction and Superintendence)

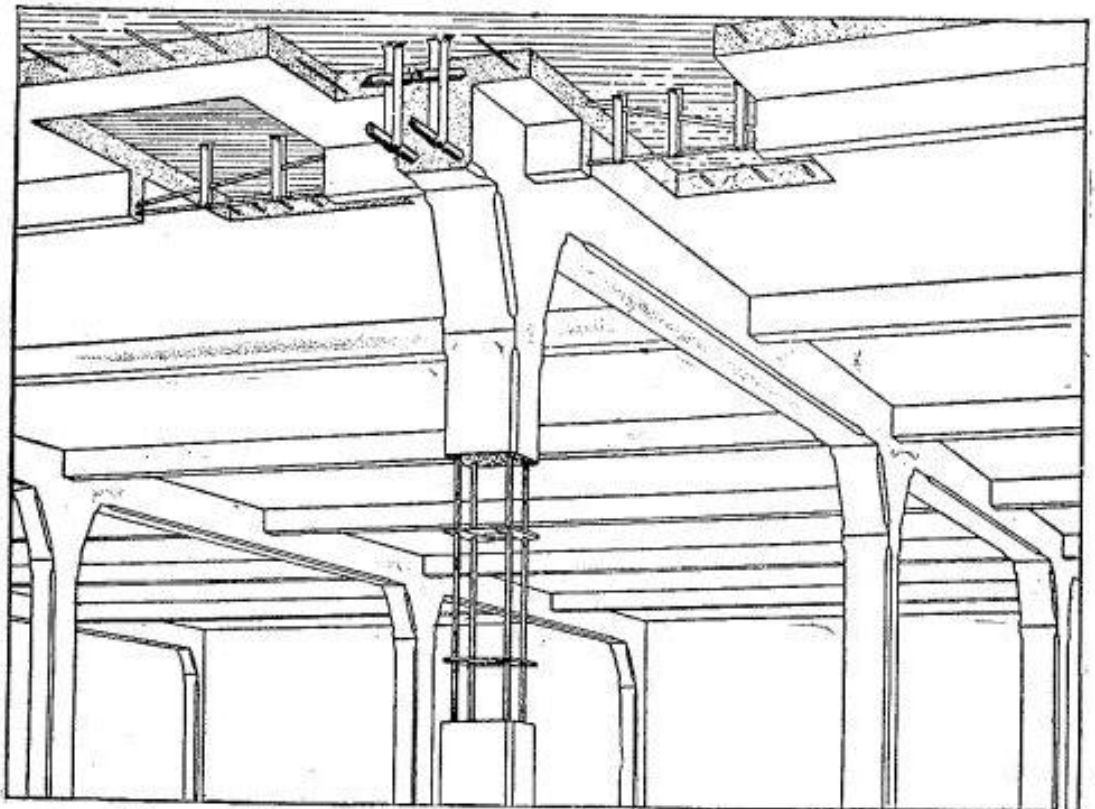

- **Corrugated**

- Arched (Source: Library of Congress)

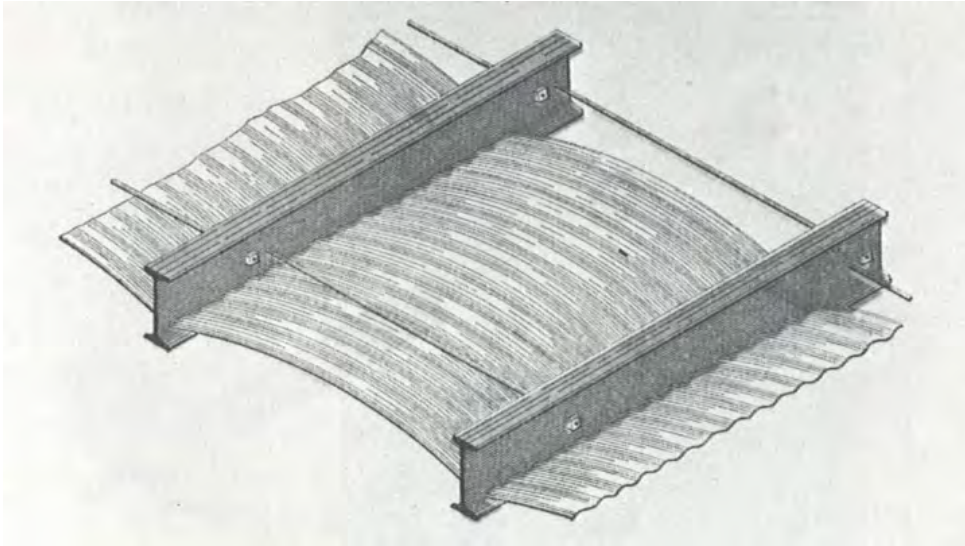

- Berger (Source: Building Construction and Superintendence)



- Buckeye
(No Image Available)

- Multiplex
(No Image Available)

- Pencoyd
(No Image Available)

- **Expanded Metal**

- Expanded Metal Company
(No Image Available)

- Manhattan
(No Image Available)

- **Inverted Tee (with brick flooring)**

- McCabe
(No Image Available)

- **Lally Column** (Source: Tubular Products Incorporated)

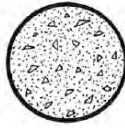
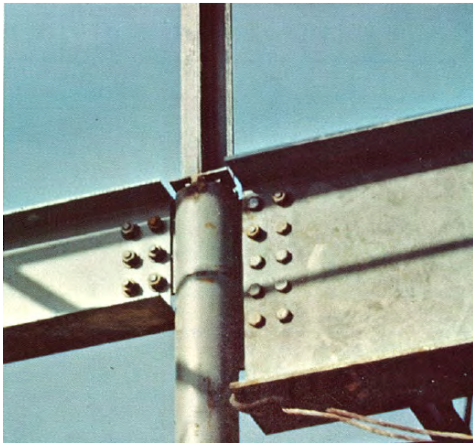

- **Pre-Engineered Open Web Joists** (Source: SJI unless noted otherwise)

- Armco
(No Image Available)

- Ashland
 - HS Series

ELEVATION AND DETAILS

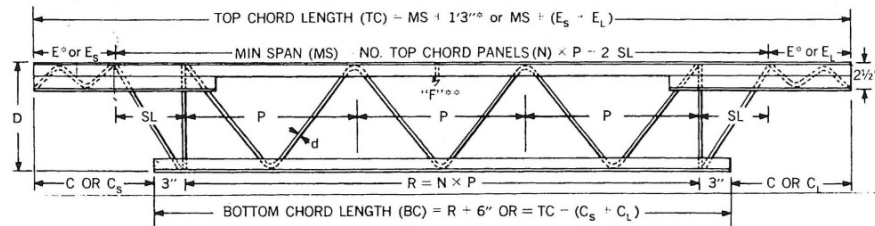

*E = 7 1/2" unless E_s and E_L specified. (NOTE: 2 E = 1'3")

***"F" Fillers having same diameter as web bar are spaced in top chord panels between quarter span points.

CROSS SECTIONS AND DETAILS

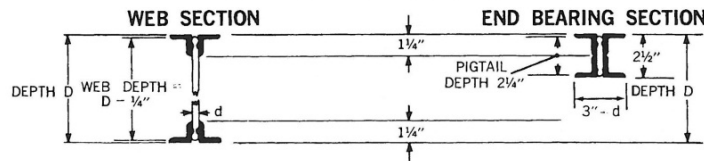

- LS Series

ELEVATION AND DETAILS

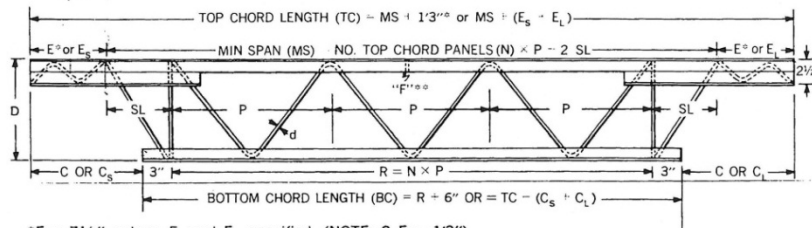

*E = 7 1/2" unless E_s and E_L specified. (NOTE: 2 E = 1'3")

***"F" Fillers having same diameter as web bar are spaced in top chord panels between quarter span points.

CROSS SECTIONS AND DETAILS

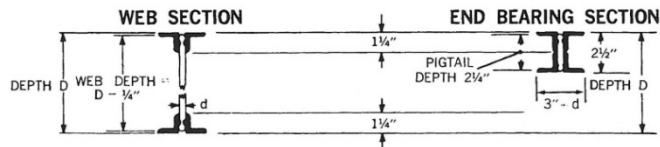

- Berger
(No Image Available)

- Bethlehem
 - BH Series

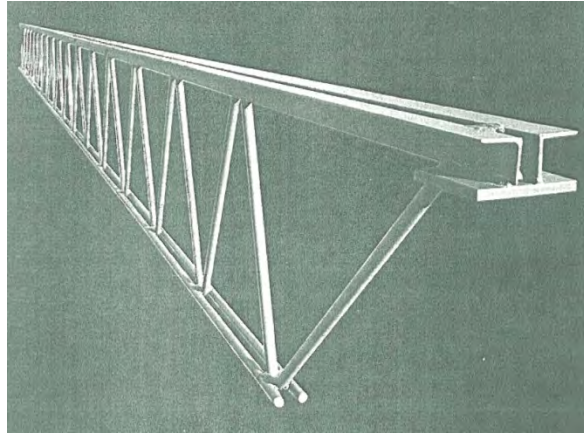

- BJ Series

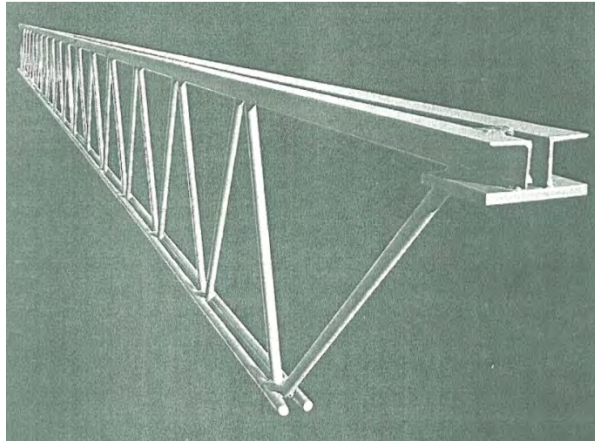

- BLH Series

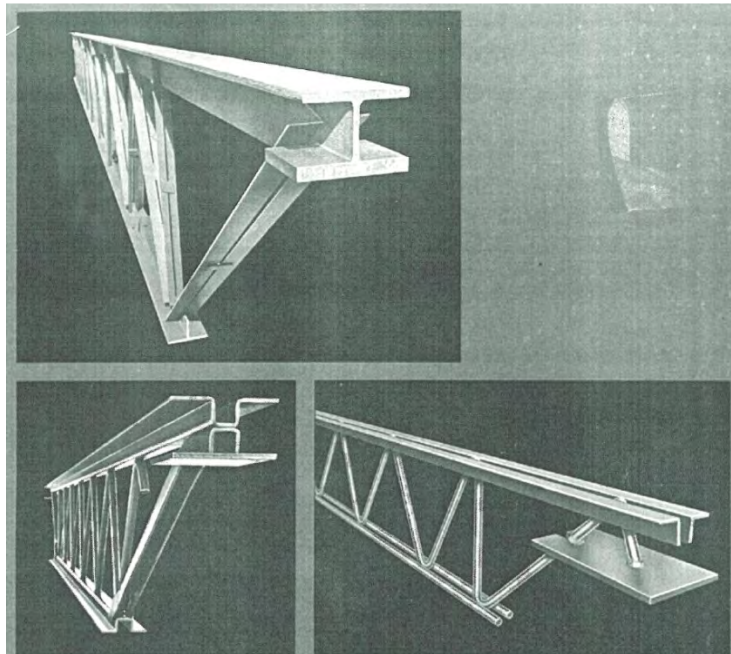

- BLJ Series

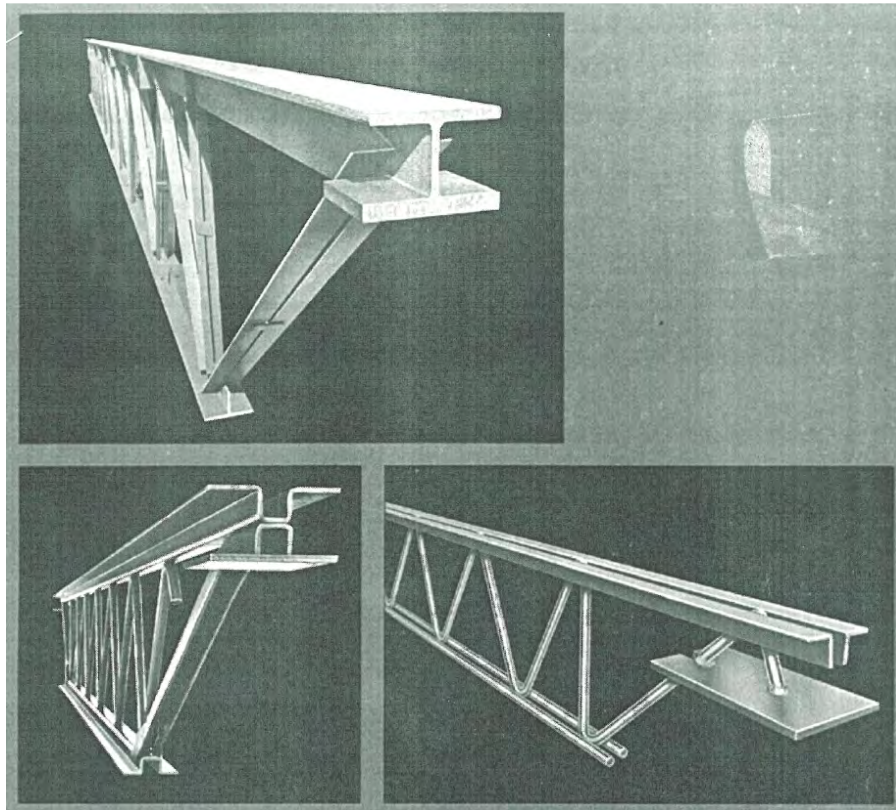

- Kalman Truss



- Longspan



RIGID BRIDGING



CEILING EXTENSION RODS

- MacMar

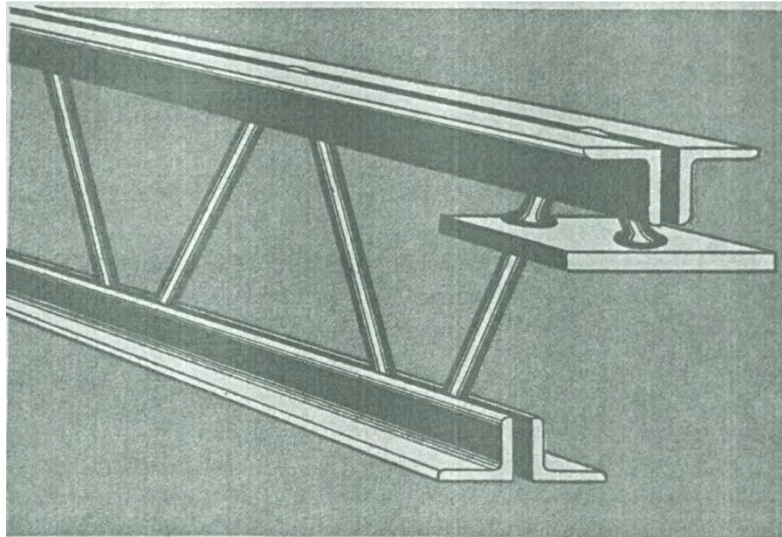

- Standard

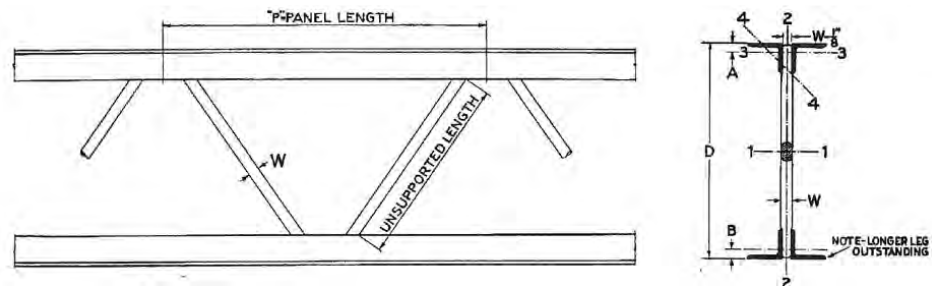

- Cadmus

- Standard

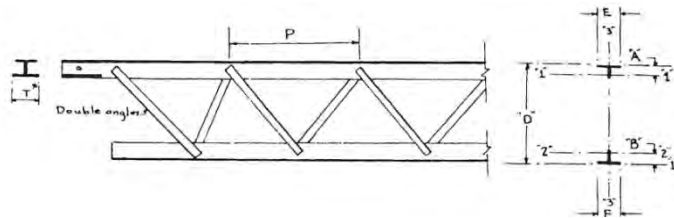

- T Longspan

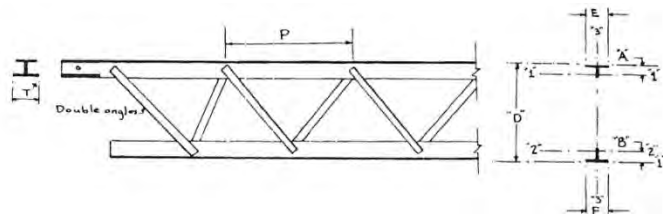

- Gabriel

- Longspan

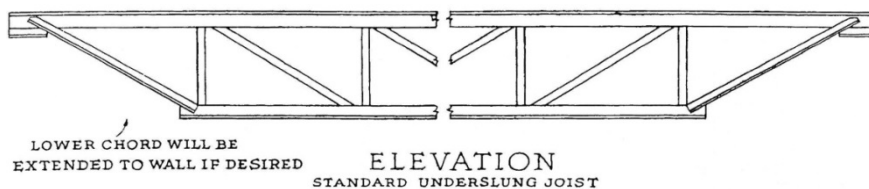

- H-Series
(No Image Available)

- Haven Busch
 - T-Chord Longspan

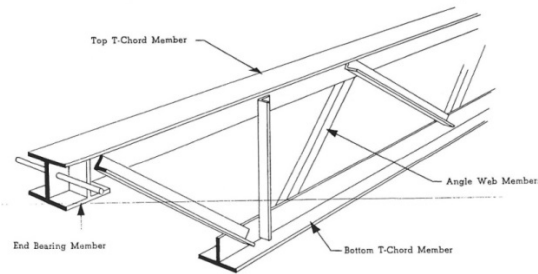

- J-Series
(No Image Available)

- Macomber
 - Allspan

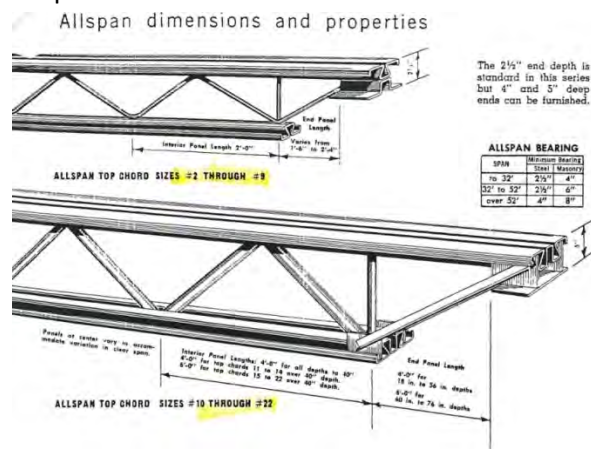

- Buffalo

BUFFALO STEEL JOIST

A RUGGED DEPENDABLE STRUCTURAL UNIT

THE CANTILEVER END PROVIDES FLEXIBILITY OF SPAN AND INCREASES SALVAGE VALUE.

THE END PLATES ARE ALL ONE QUARTER INCH THICK.

CENTERING CORRUGATED STEEL SHEETS SHEARED TO LENGTH.

SOLID STEEL ARC WELDED CONNECTIONS PROVIDE FOR GREATER STRESSES THAN THE MEMBERS THEY UNITE.

DOUBLE INVERTED ANGLE TOP CHORD

THE BEARING PLATE IS ONE QUARTER INCH THICK AND SUFFICIENTLY WIDE TO PROVIDE AMPLE BEARING ON MASONRY.

THE CEILING EXTENSION IS AN ACCESSORY ITEM USED TO COMPLETE THE CEILING LINE TO WALLS.

TWO ROUND BARS IN THE BOTTOM CHORD PROVIDE MAXIMUM FIRE RESISTANCE—PROTECTS CEILING PLASTER FROM MARKING—AND FACILITATES THE SECURE ATTACHING OF CEILING LATH AND OTHER ACCESSORY ITEMS.

MIN. SPAN 6'

MAX. SPAN 4'

BEND HERE

CEILING EXTENSION

END SECTION

MANUFACTURED By **MACOMBER INCORPORATED** CANTON, OHIO.

- Canton

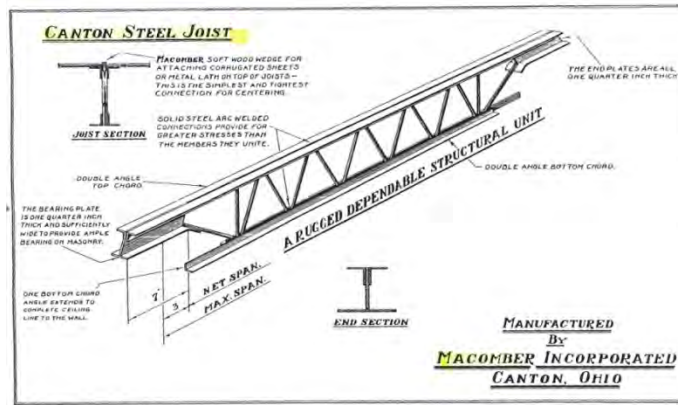

- Double V

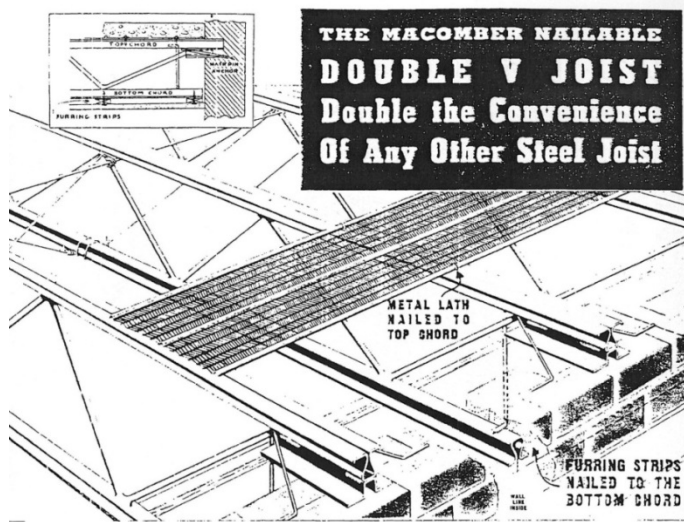

- Intermediate Longspan (No Image Available)

- Massillon

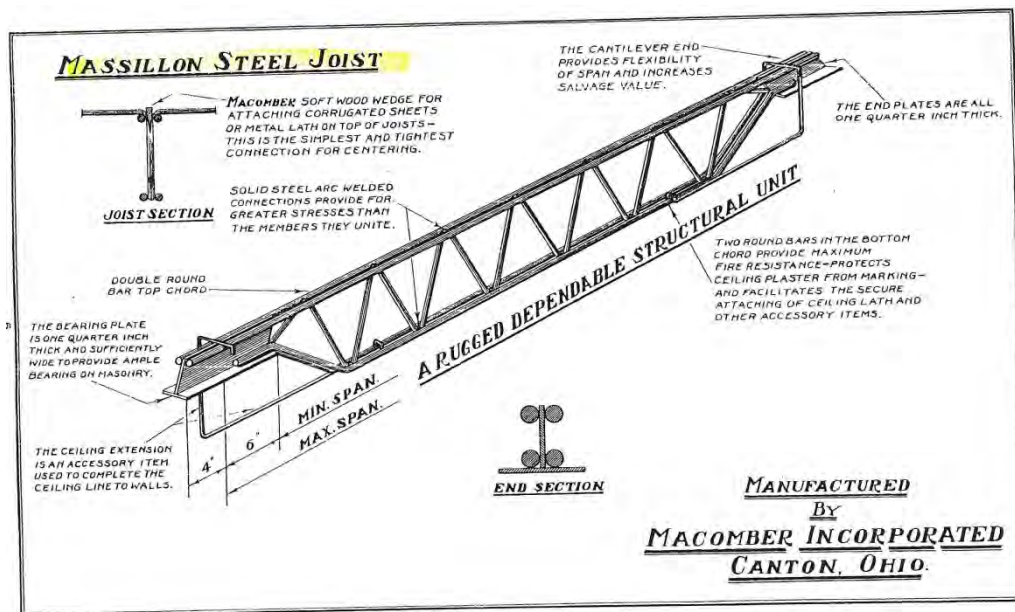

■ New Yorker

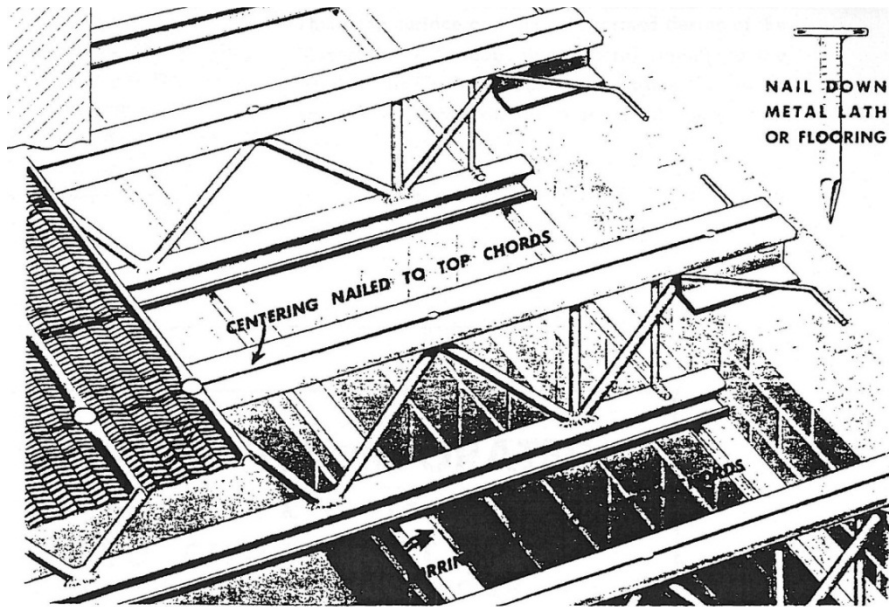

■ Purlin

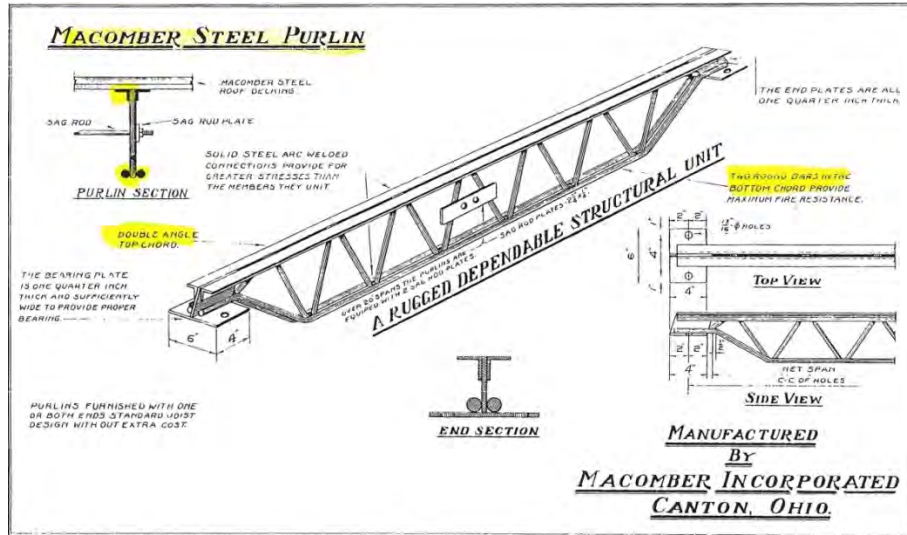

■ Residence

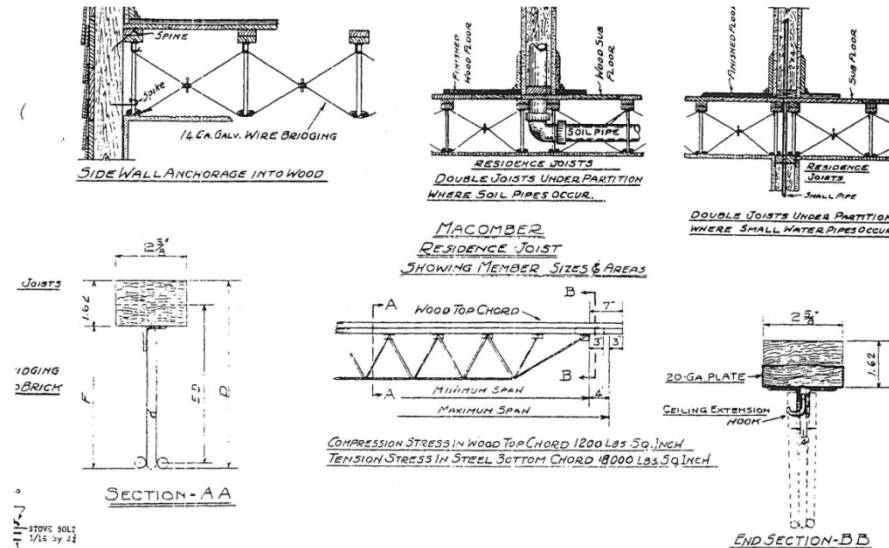

- Special
(No Image Available)
- Standard Longspan

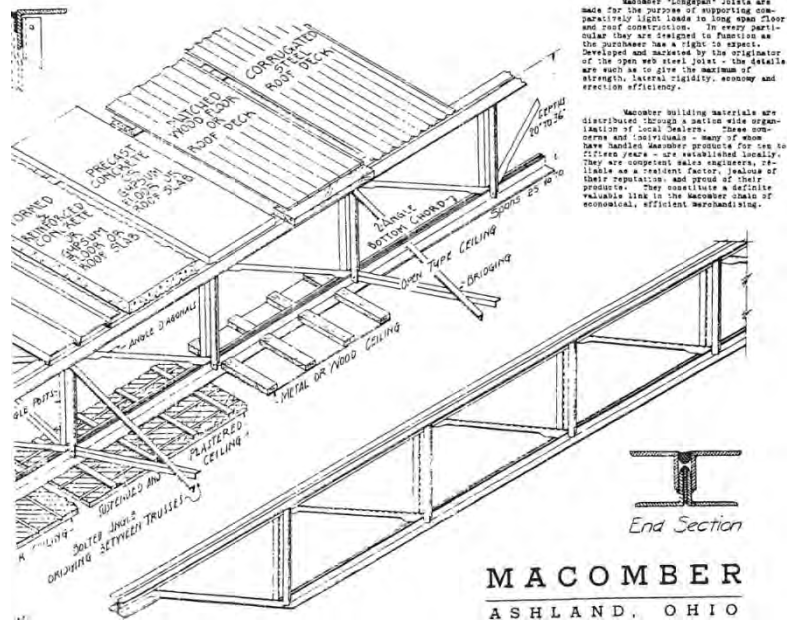

- V-Beam

THE MACOMBER V-BEAM

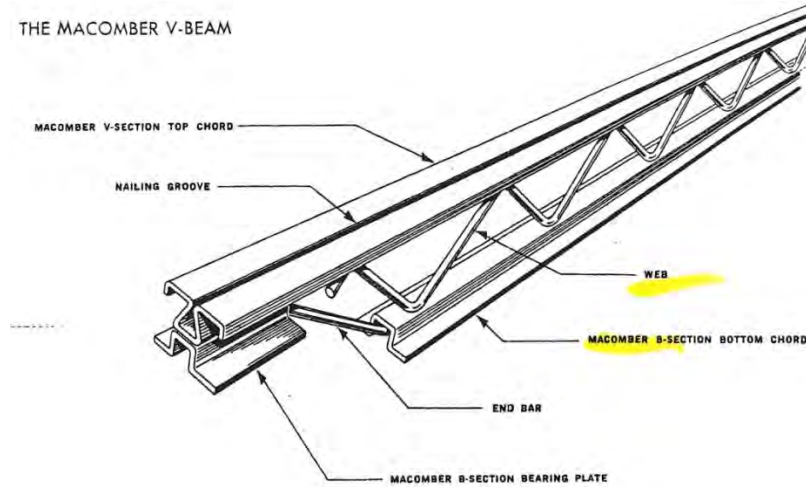

- V-Girder
(No Image Available)
- V-Lok Girder

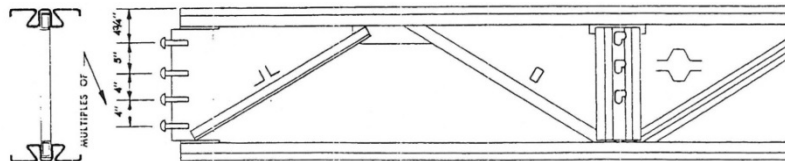

- V-Lok Purlin
(No Image Available)

- V-Purlin

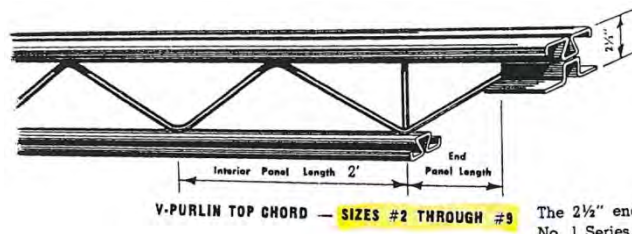

The 2 1/2" end depth is standard in the No. 1 Series, but 4" and 5" deep ends can be furnished. All panel points in this series are on 2' centers.

- Northwest

- Series 1, 2, 3 & 4

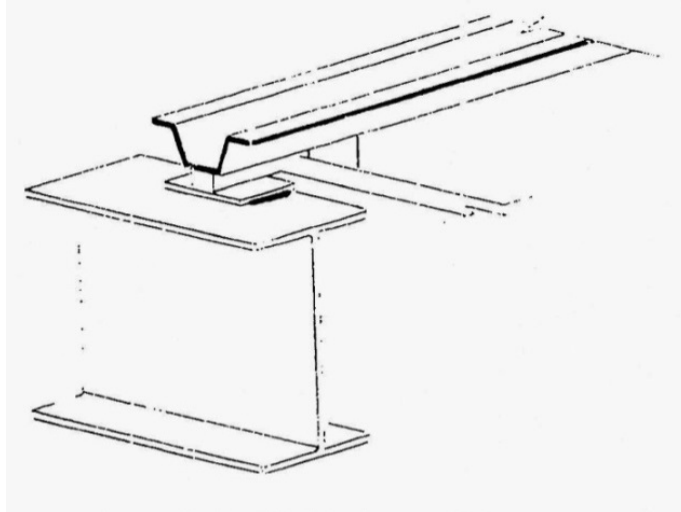

- Raychord

(No Image Available)

- Republic

(No Image Available)

- Ridgeway

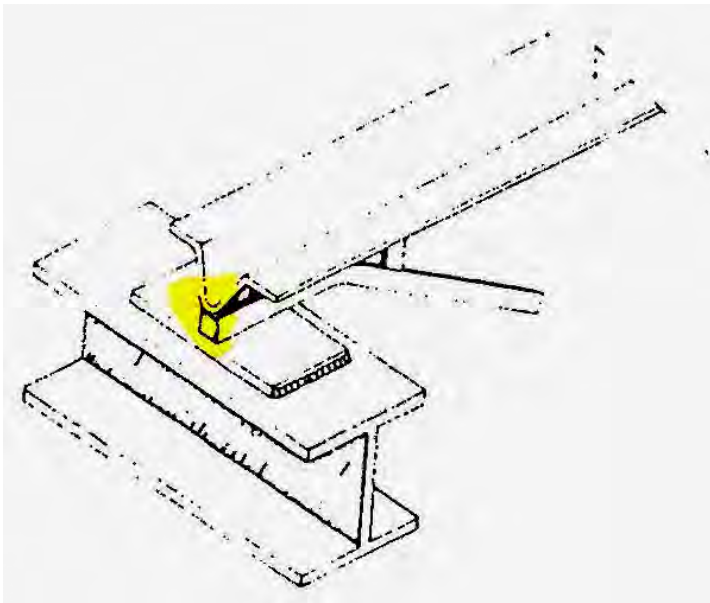

- Truscon
 - Clerespan

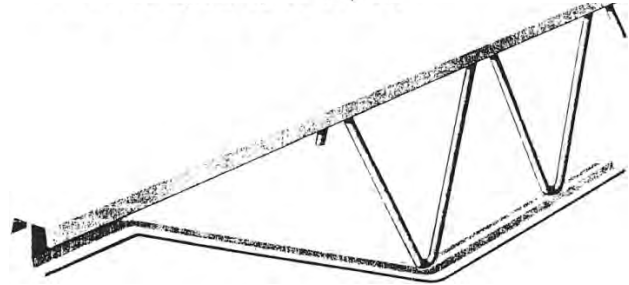
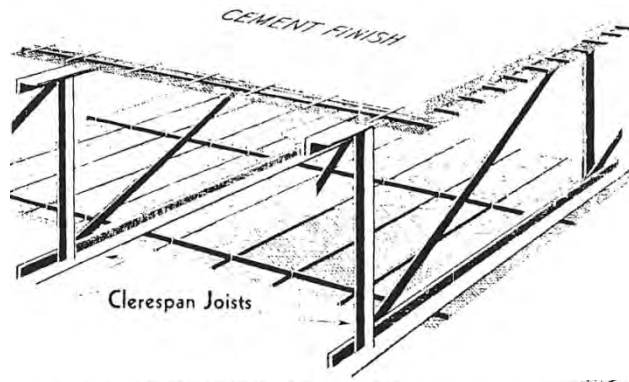

- O-T (Open Truss)

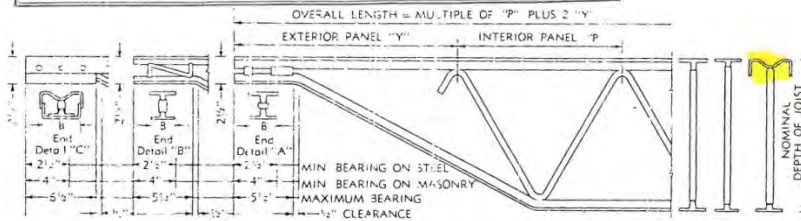
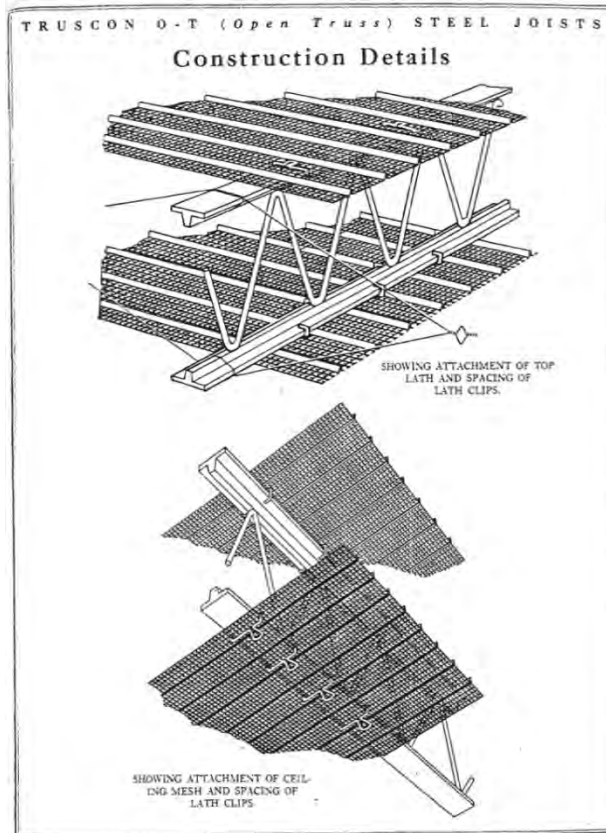

- Series AS

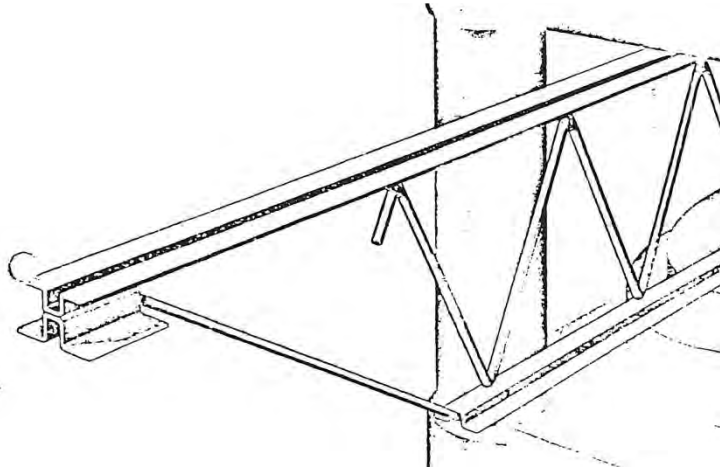

- Series BB

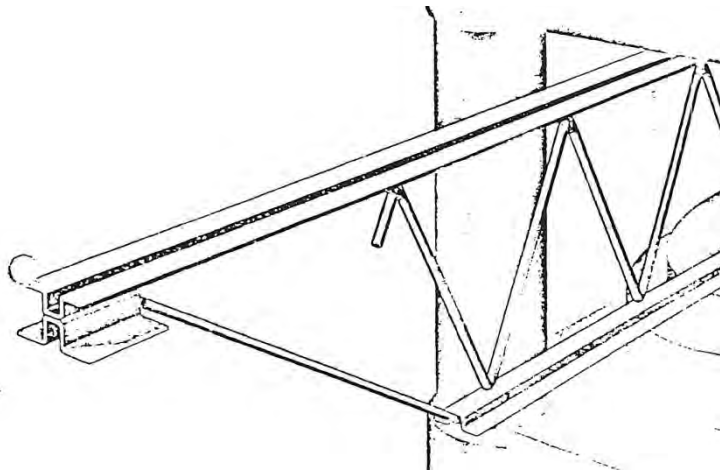

- USS Ambridge
(No Image Available)

- Vescom
 - Composite Floor Joists

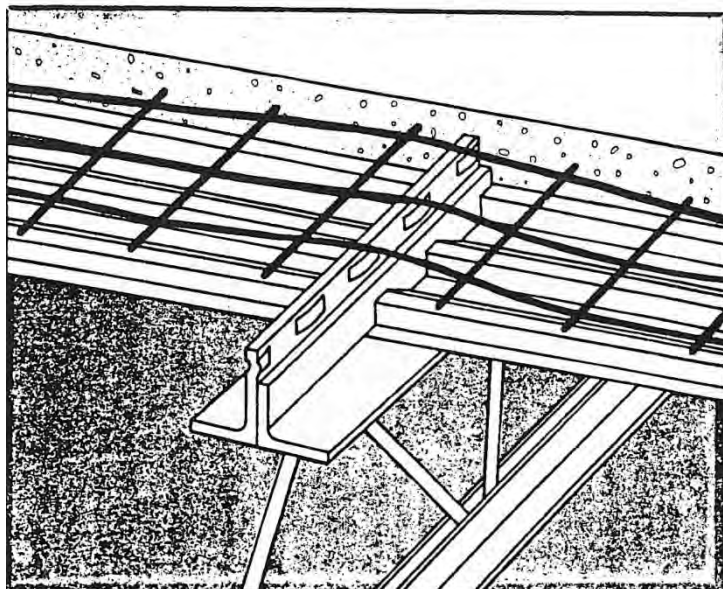

- Composite Truss Girder
(No Image Available)

- Riveted Open Web Joist (Source: DMS)



- Rolin Truss (Source: Popular Science)

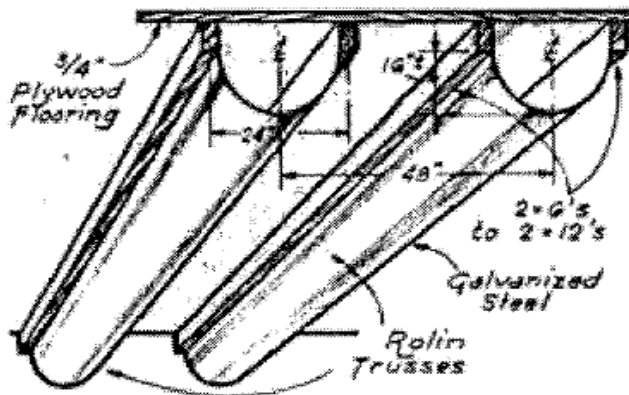

Prefabricated trusses look like stock-feeding troughs but can support up to 110 pounds psf and loaded spans up to 65 ft. Single or double layers of 16- or 18-gauge galvanized sheet steel is bent and nailed to joists.

- Truscon Steel Joist (Source: Truscon Buildings Co.)

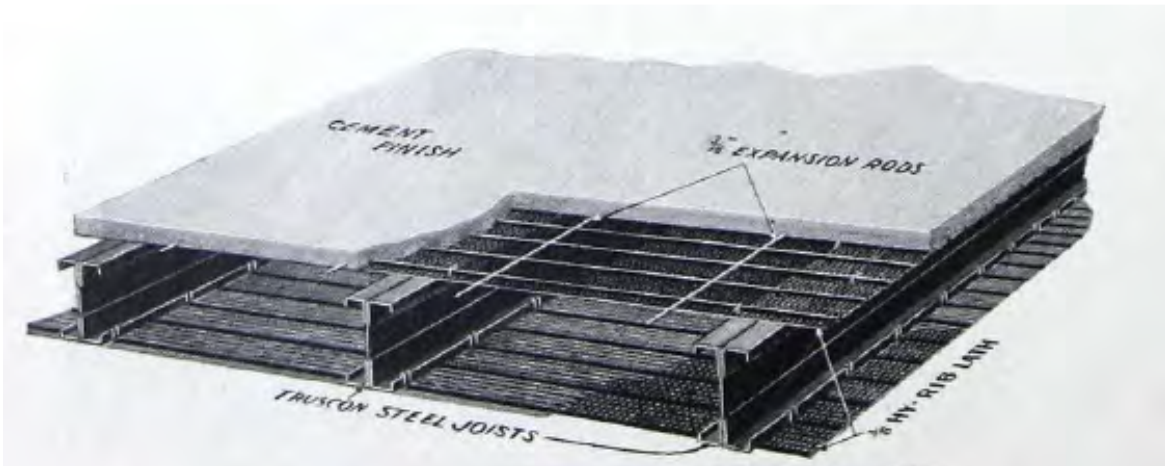

Terra Cotta:

- **Cornice** (Source: Building Construction and Superintendence)

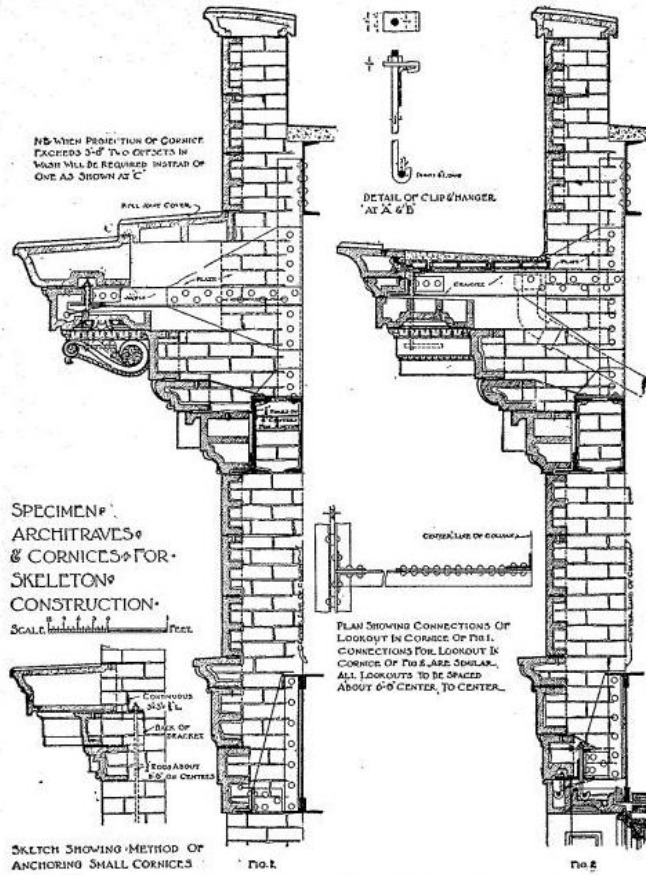
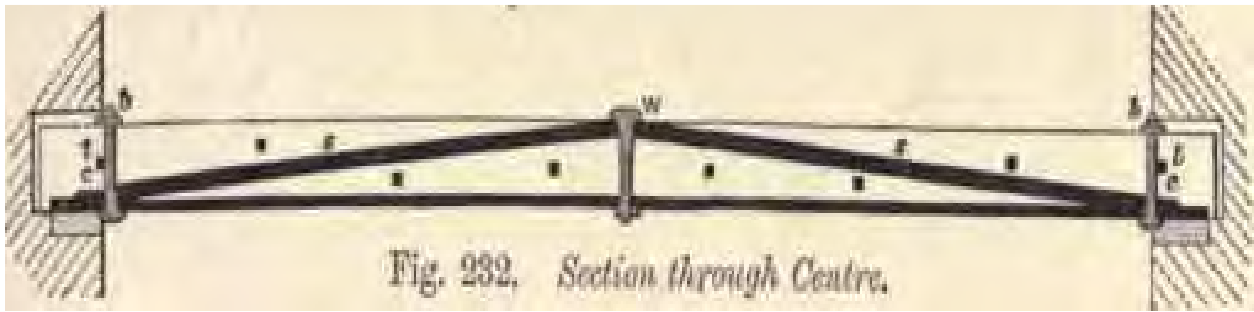

Fig. 258. Typical Terra-cotta Cornices for Skeleton Construction.

- **Guastavino Timbrel Arch** (Source: Historic American Building Survey)



- **Trussed- Beam** (Source: Notes on Building Construction)



Elevation

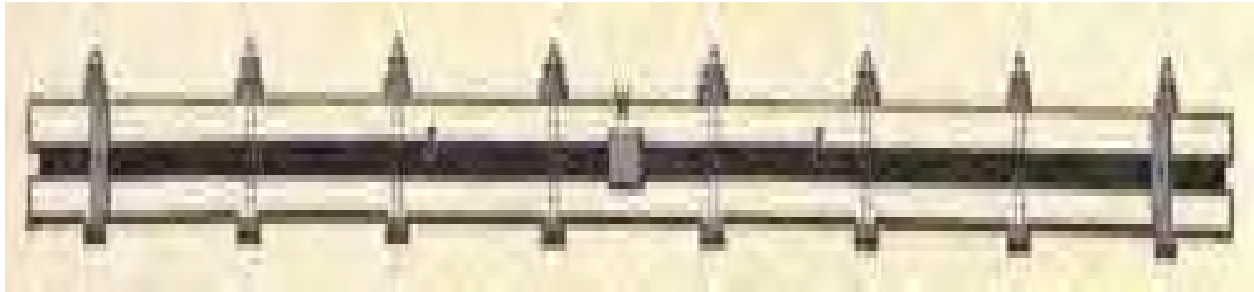

Plan

Unit Masonry:

- **One-Way Joists**
 - Kalex (Source: Jeff Poole)



- Omnia Joist and Block System (Source: Omnia Industries, Inc.)

Only Three Components

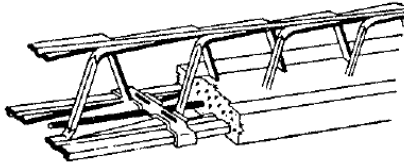

1 - Omnia Joist

Omnia joists are formed to exact lengths by enclosing the patented Omnia steel lattice in

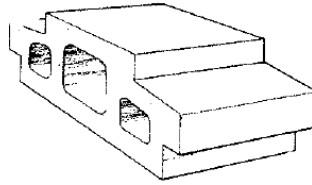

2 - Omnia Concrete Block

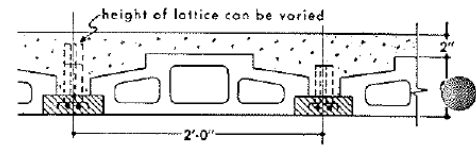

3 - Poured Concrete Forms Monolithic Structure

- Prefabricated (Source: NCMA)

- Dox Plank (Alternate)

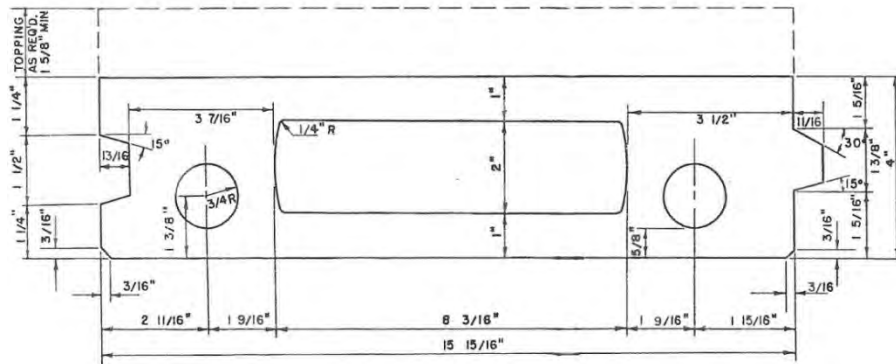

- Flexicore
(No Image Available)
- NABCO Dox Plank

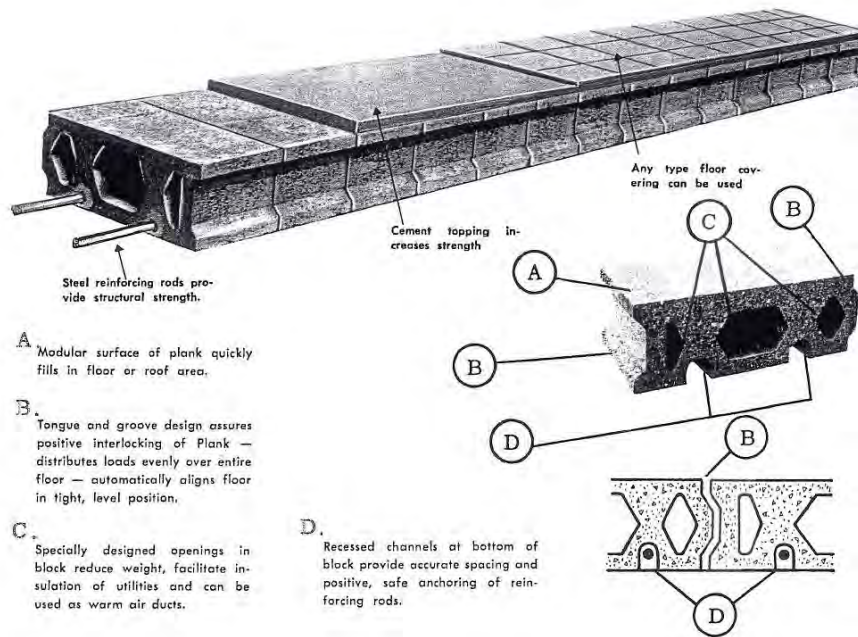

- Republic Slagblok
(No Image Available)

- **Two-Way Joists**

- Republic Slagblok (Source: DMS)



Wrought Iron:

- **Channel Beam** (Source: John Sandifer)



- **Composite Cast Iron and Wrought Iron**

- Perforated Girder (Source: Historic American Building Survey)



- Truss (Source: Peabody Essex Museum)

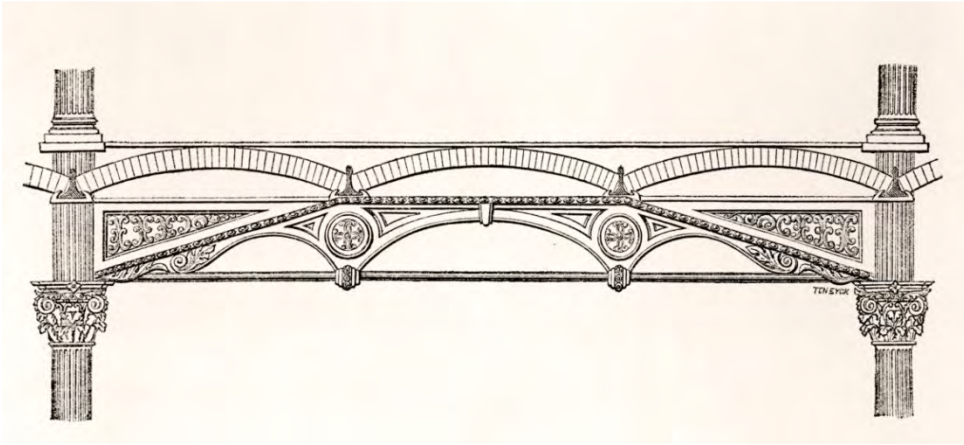

- Deck Beam (Source: John Sandifer)



- I Beam (Source: John Sandifer)

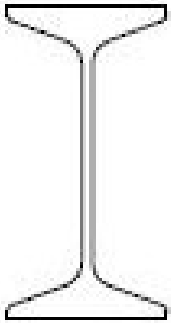

- Rail Beam (Source: John Sandifer)

